

LBH RESIDENCE

7450 North Mercer Way
Mercer Island, Washington

EXTERIOR PERMIT SET April 1, 2019

ARCHITECTURAL	CIVIL	STRUCTURAL
A-0.1 General Notes	1 of 2 Site Improvement Plan	S-1.1 Structural Notes
A-1.1 Site Plan Project Information	2 of 2 TESC & Stormwater Pollution Protection Plan	S-2.1 Foundation Plan
A-1.2 Zoning Diagrams		S-2.2 Main Level Framing Plan
A-1.3 Zoning Diagrams	LANDSCAPE	S-2.3 Upper Level Framing Plan
A-2.1 Floor Plan Lower Level	LS-1.0 Tree Inventory, Protection & Removal Plan	S-2.4 Roof Framing Plan
A-2.2 Floor Plan Main Level	LS-2.0 Landscape Plan South	S-3.1 Concrete Details
A-2.5 Floor Plan Pool Terrace	LS-2.1 Landscape Plan North	S-3.2 Concrete Details
A-3.1 Exterior Elevations North & South	LS-2.2 Planting Schedule & Notes	S-4.1 Wood Framing Details
A-3.2 Exterior Elevations East & West		S-4.2 Wood Framing Details
A-4.1 Wall Section		S-4.3 Wood Framing Details
A-5.1 Exterior Door Schedule & Diagrams		SURVEY
		Survey Page 1 of 2
		Survey Page 2 of 2

GENERAL NOTES

GN-1 GENERAL NOTE

All work to comply with the following current codes:

- 2015 INTERNATIONAL RESIDENTIAL CODE (IRC)
- 2015 SEATTLE RESIDENTIAL CODE (SRC)
- 2015 SEATTLE MECHANICAL CODE (SMC)
- 2015 SEATTLE PLUMBING CODE
- 2011 SEATTLE ELECTRICAL CODE
- 2015 SEATTLE FIRE CODE (SFC)
- 2015 WASHINGTON STATE ENERGY CODE
- 2015 SEATTLE FUEL GAS CODE (Natural Gas)
- All Seattle Amendments to the above codes
- and all other applicable local codes

GN-2 GENERAL NOTE

All applicable codes, ordinances, and minimal structural requirements take precedence over drawings, notes, and specifications.

GN-3 GENERAL NOTE

Dimensions are to face of stud unless noted otherwise.

GN-4 GENERAL NOTE

Plumbing work and Electrical work is "Design/Build" and executed under separate permit.

EARTH WORK

EW-1 VERIFY SOIL CONDITIONS

Geotechnical Engineer shall field verify conformance of actual soil conditions with design assumptions.

EW-2 GEOTECHNICAL ENGINEER SITE VISITS

General contractor is responsible for scheduling site visits by Geotechnical Engineer.

EW-3 BEARING DEPTH

Extend excavation down to undisturbed soil of the specified strength with a minimum depth of 18" below finish grade.

EW-4 COMPACTED FILL

Compacted fill to be well graded and granular with no more than 5% passing a 200 sieve. Place in 8" loose lifts and compact to 95% modified AASHO density at optimum moisture content.

EW-5 BACKFILL

Backfill behind all retaining walls with free draining granular fill and provide for subsurface drainage. (Subject to field review by Geotechnical Engineer)

MOISTURE PROTECTION

MP-1 (2015 IRC R311.1)

Provide a minimum clearance of 12" between untreated beams & girders and earth.

Provide a minimum clearance of 18" between untreated joists and earth.

Provide a minimum of 8" clear between untreated framing members in contact concrete or masonry exterior walls and earth.

All wood in contact with concrete or masonry exterior walls to be pressure treated.

All sills and sleepers on concrete slab that is in direct contact with the earth to be pressure treated.

All wood in direct contact with the ground or embedded in concrete shall be pressure treated.

Wood siding, sheathing and framing shall have a clearance of 6" to earth and 2" from concrete steps, porch slabs, patio slabs and similar horizontal surfaces exposed to weather.

MP-2 (2015 IRC R406) CRAWLSPACE VENTILATION

Crawlpace ground surface shall be covered with a Class 1 (0.1 per or less) vapor retarder material.

Provide 1 sf of net free vent area for each 1500 sf of crawlpace area.

A vent shall be located within 3 feet of each corner.

Vents shall be protected by 1/8" minimum, 1/4" maximum non-corrosive screen.

MP-3 (2015 IRC R806) ROOF VENTILATION

Provide 1 sf of net free vent area for each 150 sf of attic area.

Venting may be reduced to 1 sf of net free vent area for each 300 sf of attic area provided at least 40% but no more than 50% of the vent area is located in the upper portion of the roof at least 3 feet above the eave.

Vents shall be protected by 1/8" minimum, 1/4" maximum non-corrosive screen or approved soffit vents.

A minimum 1" clear air space shall be provided between the insulation and the roof sheathing through the roof.

All rafter bays to be ventilated.

FIRE PROTECTION

FP-1 (2015 IRC R302.6) SEPARATION REQUIRED

The garage shall be separated from the residence and its attic by not less than 1/2" thick GWB on the garage side. Garages beneath habitable rooms above by not less than 5/8" thick GWB Type X. Where the separation is a ceiling-floor assembly the structure supporting the assembly shall also be protected by not less than 1/2" thick GWB.

FP-2 (2015 IRC R302.5) OPENING PROTECTION

Openings between garage and residence shall be protected by either

- Solid wood door not less than 1 3/8" thick, or
- Solid or honeycomb metal door not less than 1 3/8" thick, or
- 20-minute fire rated door equipped with self-closing device

FP-3 (2015 IRC R302.5.2) DUCT PENETRATION

Ducts in the garage and ducts penetrating the walls or ceiling separating the dwelling from the garage shall be a minimum of 26 gauge sheet metal and have no openings into the garage.

FP-4 (2015 IRC R302.7) UNDER-STAIR PROTECTION

Enclosed accessible space under stairs shall have walls and under-stair-surfaces protected on the enclosed side by not less than 1/2" thick GWB.

FP-5 (2015 IRC R314.1) SMOKE DETECTION AND NOTIFICATION

All smoke alarms shall be listed in accordance with UL 217 and installed in accordance with the provisions of the IRC and the household fire warning equipment provisions of NFPA 72.

FP-6 (2015 IRC R314.3.4) SMOKE DETECTION LOCATION & INTERCONNECTION

Smoke alarms shall be installed in the following locations

- In each sleeping room
 - Outside each separate sleeping area in the immediate vicinity of the bedrooms
 - On each additional story of the building including basements and habitable attics
- When more than one smoke alarm is required to be installed within an individual dwelling unit, the alarm devices shall be interconnected in such a manner that the actuation of one alarm will activate all of the alarms in the individual unit.

FP-7 (2015 IRC R314.2.2) SMOKE ALARMS - ALTERATIONS, REPAIRS AND ADDITIONS

When alterations, repairs or additions requiring a permit occur, or when one or more sleeping rooms are added or created in existing dwellings, the individual dwelling unit shall be equipped with smoke alarms located as required for new dwellings.

FIRE PROTECTION cont'd.

FP-8 (2015 IRC R314.6) SMOKE ALARM POWER SOURCE

Smoke alarms shall receive their primary power from the building wiring where such wiring is served from a commercial source and, where primary power is interrupted, shall receive power from a battery. Wiring shall be permanent and without disconnecting switch than those required for overcurrent protections.

FP-9 (2015 IRC R315.12) CARBON MONOXIDE ALARMS

For new construction, an approved carbon monoxide alarm shall be installed outside of each separate sleeping area in the immediate vicinity of the bedrooms in dwelling units within which fuel-fired appliances are installed and in dwelling units that have attached garages.

When alterations, repairs or additions requiring a permit occur, or when one or more sleeping rooms are added or created in existing dwellings, the individual dwelling unit shall be equipped with carbon monoxide alarms located as required for new dwellings.

FP-10 (2015 IRC R315.11) CARBON MONOXIDE ALARM REQUIREMENTS

Single station carbon monoxide alarms shall be listed as complying with UL 2034 and shall be installed in accordance with this code and the manufacturer's installation instructions.

FP-11 (2015 IRC R315.5) POWER SOURCE

Carbon monoxide alarms shall receive their primary power from the building wiring where such wiring is served from a commercial source and, where primary power is interrupted, shall receive power from a battery. Wiring shall be permanent and without disconnecting switch than those required for overcurrent protections.

FP-12 (2015 IRC R302.11) FIREBLOCKING REQUIRED

Fire blocking is required in the following locations.

-In concealed spaces of stud walls and partitions including furred spaces, parallel rows of studs, staggered studs as follows:

Vertically at ceiling and floor levels

Horizontally at intervals not exceeding 10' feet

-At all interconnections between concealed vertical and horizontal spaces such as soffits, dropped ceilings, and covered ceilings

-In concealed spaces between stair stringers at the top and bottom of the run.

-At openings around vents, pipes, ducts, cables, and wire at ceiling and floor level

-At fireplaces & chimneys per IRC R1003.15

-Fireblocking conical of a 2-family dwelling is required at the line of dwelling unit separation

SAFETY AND SECURITY

SS-1 (2015 IRC R308.4) SAFETY GLAZING - HAZARDOUS LOCATIONS

Provide safety glazing in the following locations

- Glazing in swinging doors

- Glazing in fixed and sliding panels of sliding door assemblies and panels in sliding and bi-fold closet door assemblies

- Glazing in storm doors

-Glazing in unframed swinging doors

- Glazing in door or enclosure for hot tub, whirlpool, sauna, steam room, bathtub, and shower. Glazing in any part of the a building wall enclosing these where the the bottom edge of the glazing is less than 60" above a standing or walking surface.

- Glazing in an individual fixed or operable panel adjacent to a door where the nearest vertical edge is within a 24" arc of the door in a closed position AND whose bottom edge is less than 60" from the floor or walking surface.

- Glazing that meets all of the following conditions

- Exposed area of an individual pane larger than 9 sf
- Bottom edge less than 18" above the floor
- Top edge more than 36" above the floor
- Walking surface within 36" horizontally of the glazing

-All glazing in railings (regardless of area or height).

-Glazing in walls and fences enclosing swimming pools, hot tubs, spas where the bottom edge is less than 60" above walking surface and within 60" horizontally of the water's edge.

-Glazing adjacent to stairways, landings, and ramps within 36" horizontally of a walking surface when the exposed surface of the glass is less than 60" above the the plane of the adjacent walking surface.

-Glazing adjacent to stairways within 60" horizontally of the bottom tread in any direction when the exposed surface of the glass is less than 60" above the nose of the tread.

(SEE CODE SECTION FOR LIMITED LIST OF EXCEPTIONS)

SS-2 (2015 IRC R310.12.3.4) EMERGENCY ESCAPE (EGRESS)

Emergency escape opening shall have a minimum net clear opening of 5.7 sf

Grade floor openings shall have a minimum net clear opening of 5.0 sf

- Emergency escape opening shall have a minimum net clear opening height of 24"
- Emergency escape opening shall have a minimum net clear opening width of 20"
- Emergency escape opening shall have a maximum sill height of 44"

SS-3 (2015 IRC R311.2) EXIT DOOR

Not less than one exit door shall be provided.

Minimum size of 32" x 18"

SS-4 (2015 IRC R311.7) STAIRWAYS

WIDTH

Stairway width shall be no less than 36" in clear width above the handrail height and below the required headroom height, handrails may project no more than 4.5" on either side of the stairway

HEADROOM

The minimum headroom of all parts of the stairway shall be no less than 6'-8" measured vertically from the sloped plane adjoining the tread nosings.

RISER HEIGHT

The maximum riser height is 7-3/4"

The maximum discrepancy between tallest & shortest risers shall not exceed 3/8".

TREAD DEPTH

The minimum tread depth is 10" measured from nosing projection to nosing projection

The maximum discrepancy between widest & narrowest treads shall not exceed 3/8".

NOISING

Provide a nosing not less than 3/4" but not more than 1-1/4" wide on stairways with solid risers.

HANDRAIL

A continuous handrail is required on at least one side of each continuous run of treads or flight with 4 or more risers.

HANDRAIL HEIGHT

Not less than 34" or more than 38" above the sloped plan adjoining the tread nosings.

HANDRAIL CONTINUITY

Handrail shall be continuous for the full length of the flight from a point directly above the top riser to a point directly above the bottom riser. Handrails shall be returned to the wall or terminate in a newel post or safety terminus.

SAFETY AND SECURITY cont'd

HANDRAIL SPACE

There shall be a space of no less than 1-1/2" between handrail and adjacent wall surface.

HANDRAIL GRIP SIZE

Handrails with a circular cross section shall have an outside diameter of at least 1-1/4" and no more than 2". If the handrail is not circular it shall have a perimeter dimension of at least 4" and not more than 6-1/4" with a maximum cross section dimension of 2-1/4" (See code for additional options).

SS-5 (2015 IRC R312) GUARDS

Porches, balconies, ramps, and raised floor surfaces more than 30" above the floor or grade below shall have a guard not less than 36" in height.

Open side of stairs with a total rise of 30" or more shall shall have guards a minimum height of 34" above nosings.

Guards shall have intermediate rails or balusters spaced so as not to allow the passing of a 4" diameter sphere.

BATHROOM NOTES

BN-1 (2015 IRC 307.1) SPACE REQUIREMENTS

Toilet - Minimum 15" clear each side, Minimum 21" clear in front of bowl

Vanity - Minimum 21" clear in front

Shower - Minimum 30" x 30", 24" clear in front of opening

BN-2 (2015 IRC 307.2) TUB & SHOWER WALLS

Bathtub and shower floors and walls above bathtubs with shower heads shall be finished with a non-absorbant surface to a height of at least 6 feet above the floor.

ENERGY CODE

EC-1 CODE

All work to comply with 2015 Washington State Energy Code (WSEC).

EC-2 (2015 WSEC R402) BUILDING ENVELOPE REQUIREMENTS

Climate Zone 4C (Marine) - King County

Compliance Path: Mandatory plus Prescriptive

Table 402.11

Penetration U-Factor: (Vertical windows & doors): 0.28

Skylight U-Factor (Overhead): 0.50

Penetration SHGC NR

Ceiling Insulation: R-49 or R-38 adv

Vaulted Ceiling Insulation: R-38

Wood framed wall insulation (above grade): R-21 int (R-21 cavity + R-10 insulated headers)

Mass Wall Insulation: R-21

Wall Insulation (interior below grade): R-15 continuous or

R-21 cavity + R5 thermal break between

slab & basement wall

R-10 continuous

R-30

R-10 (First 24")

R-10 continuous

Wall Insulation (exterior below grade):

Floor Insulation:

Slab on Grade Insulation

Heated Slab on Grade Insulation

See Table 402.11 for footnotes

EC-3 (2015 WSEC R406) ADDITIONAL ENERGY EFFICIENCY REQUIREMENTS

Dwelling units shall comply with all provisions of WSEC Chapter 4 and shall comply with

sufficient options from Table R406.2 so as to achieve the at least the minimum number of

Energy Credits as required (WSEC R406.2). Refer to Floor Plans, Sheets A-04 and A-05

for selected Energy Credit Options.

EC-4 (2015 WSEC R402.2.4) ACCESS HATCHES & DOORS

Access hatches from conditioned spaces to crawlspaces and attics shall be weatherstripped and insulated to a level equivalent to the surrounding surfaces.

EC-5 (2015 WSEC R303.13) FENESTRATION (DOOR & WINDOW) U-FACTOR LABELS

All products shall be identified with NFRC 100 labels indicating U-value, SHGC (or VT).

EC-6 (2015 WSEC TABLE 402.4.11) AIR BARRIER

A continuous air barrier shall be installed in the building envelope. Breaks or joints in the barrier shall be sealed. Air-permeable insulation shall not be used as a sealing material.

EC-7 GROUND COVER

A ground cover of 6 mil black polyethylene, Class 1 (0.1 per or less), vapor retarder material shall be installed over the ground in crawlspaces. Joints shall be lapped 12" and the ground cover should extend to the foundation walls. Ground cover can be omitted if crawlspaces have a concrete slab with a minimum thickness of 3-1/2".

EC-8 (2015 WSEC R402.4.3) AIR LEAKAGE OF FENESTRATION

Exterior doors and windows shall be constructed to limit air leakage and be fitted with weatherstripping. Joints around door and window frames, openings between walls and foundations, between walls and roof, and any other penetrations shall be sealed, caulked, gasketed, or weatherstripped to prevent air leakage. Windows, skylights and sliding glass doors shall have an air infiltration rate of not more than 0.3 cfm per square foot, and swinging doors no more than 0.3 cfm per square foot, and be listed and labeled by the manufacturer.

EC-9 (2015 WSEC R402.4.4) RECESSED LIGHTING

Recessed light cans installed in the building envelope shall be Type IC rated and certified under ASTM 283 to have no more than 2.0 cfm air movement into the unconditioned cavity. They shall be installed with a gasket or caulk between the frame and the ceiling to prevent air leakage.

EC-10 (2015 WSEC 503.7) EQUIPMENT PERFORMANCE

Heating and cooling equipment shall be sized in accordance with ACCA Manual S based on building loads calculated in accordance with ACCA Manual J or other approved heating and cooling calculation methodologies. The output capacity of heating and cooling equipment shall not be greater than that of the smallest available equipment size that exceeds the loads calculated, including allowable oversizing limits. New or replacement heating and cooling equipment shall have an efficiency rating equal to or greater than the minimum required by federal law for the geographic location where the equipment is installed.

EC-11 (2015 WSEC R403.6) MECHANICAL VENTILATION

Mechanical ventilation system fans shall meet the efficacy requirements of Table R403.6.1.

EC-12 (2015 WSEC R403.1) CONTROLS

Provide a programmable thermostat for regulation of temperature. Thermostat shall allow for a 5-2 programmable schedule (weekdays/weekends) and be capable of providing at least two programmable setback periods per day.

EC-13 (2015 WSEC R403.3) DUCTS

Ducts within or partial exposed to unconditioned spaces shall be insulated to a minimum of R-8 (WSEC R403.3.1). Framing cavities shall not be used as ducts or plenums. Installation of ducts in exterior walls shall not displace required envelope insulation (WSEC R403.3.5).

EC-14 (2015 WSEC R403.3.2) SEALING OF MECHANICAL SYSTEM

Ducts, air handlers, and filter boxes shall be sealed. Joints and seams shall comply with either the International Mechanical Code or International Residential Code, as applicable.

EC-15 (2015 WSEC R403.3.3) DUCT TESTING

Ducts shall be leak tested in accordance with WSU RS-33, using the maximum duct leakage rates specified. A written report of the results shall be signed by the party conducting the test and provided to the building inspector. A signed affidavit documenting the duct leakage test results shall be provided to the building inspector prior to an approved final inspection.

ENERGY CODE cont'd

EC-16 (2015 WSEC R403.4) MECHANICAL SYSTEM PIPING

Mechanical system piping capable of carrying fluids above 105 deg. F or below 55 deg. F shall be insulated to a minimum of R-6.

EC-17 (2015 WSEC R403.5.3) HOT WATER PIPE INSULATION

Insulation for hot water pipes shall have a minimum thermal resistance of R-3.

EC-18 (2015 WSEC R403.5.5) ELECTRIC WATER HEATER INSULATION

Electric water heaters in unconditioned space or on concrete floors shall be placed on an incompressible insulated surface with a minimum R-10.

EC-19 (2015 WSEC R404.1) LIGHTING EQUIPMENT

A minimum of 75 percent of permanently installed lamps in lighting fixtures shall be high efficacy lamps.

EC-20 (2015 WSEC 402.4.12) AIR LEAKAGE TESTING

The building or dwelling shall be tested and verified to have an air leakage rate not exceeding 5 air changes per hour. Testing shall be conducted with a blower door at a pressure of 0.2 inches w.g. Where required by the building official testing shall be conducted by an approved third party. Testing shall be performed any time after creation of all penetrations in the building thermal envelope. The test results shall be posted on the Residential Energy Compliance Certificate.

EC-21 (2015 WSEC 401.3) ENERGY COMPLIANCE CERTIFICATE

A Residential Energy Compliance Certificate is required to be completed by the design professional or builder and permanently posted on a wall in the space where the furnace is located, a utility room, or an approved location inside the building.

EXHAUST SYSTEMS CODE

VC-1 CODE

All work to comply with 2015 International Residential Code (IRC), Chapter 15, Exhaust Systems.

VC-2 (2015 IRC Section M1507) MECHANICAL VENTILATION

Source Specific Exhaust Fans

- Exhaust fans providing source specific ventilation shall have a minimum fan flow rating not less than 50 cfm intermittent for bathrooms, laundries, or similar rooms and 100 cfm intermittent for kitchens.

- Source specific ventilation systems shall be controlled by manual switches, dehumidistats, timers, or other approved means.

- Source specific ventilation ducts shall terminate outside the building. Exhaust ducts shall be equipped with backdraft dampers. All ducts in unconditioned spaces shall be insulated to a minimum of R-8.

VC-3 (2015 IRC Section M1507.3) WHOLE HOUSE MECHANICAL VENTILATION

WHOLE-HOUSE mechanical ventilation systems shall be designed in accordance with sections M1507.3 through M1507.3.3.

- Integrated whole house ventilation systems shall provide outdoor air at a continuous rate of not less than that determined in accordance with Table M1507.3.1.

VICINITY MAP	PROJECT DATA	PROPERTY DATA	CONSTRUCTION DATA	ENERGY DATA
<p>Not to Scale</p>	<p>OWNER Sean & Lori Kell 14033 SE 92nd Street Newcastle, Washington 98059 (206) 954-3004 Phone CONTACT: Sean Kell sean_kell@yahoo.com</p> <p>ARCHITECT Stillwell Hanson Architects 46 Etruria Street Suite 200 Seattle, Washington 98109 CONTACT: Craig Stillwell craig@stillwellhanson.com Email</p> <p>STRUCTURAL ENGINEER Swenson Bay Faget 2124 3rd Avenue Suite 100 Seattle, WA 98121 (206) 443-6212 Phone CONTACT: Dan Bay dbay@swensonsbayfaget.com Email</p> <p>CONTRACTOR Hoxie Huggins Construction 46 Etruria Street #202 Seattle, Washington 98109 (206) 456-5266 ext-101 CONTACT: Rob Hoxie rob@hoxiehuggins.com Email</p>	<p>PROJECT ADDRESS 7450 North Mercer Way Mercer Island, Washington 98040</p> <p>ZONING DESIGNATION R-15</p> <p>HEIGHT LIMIT 30'-0"</p> <p>SETBACKS Front (South) 20'-0" Side (5'-0" minimum) Combined 15'-0" Rear (North) from OHW Line 25'-0"</p> <p>LOT AREA 30,945 sq ft (per Survey)</p> <p>ASSESSOR'S TAX NUMBER 531510-0125</p> <p>LEGAL DESCRIPTION MC GILVERAS ISLAND ADD ALL 9 & POR OF 10 WLY OF FOLG LN- BEG AT PT ON S LN BLK 2 DIST 104.18 FT W FRM SE COR OF SD BLK TH N 10 DEG 51' MIN 20 SEC E 91.30 FT TH N 03 DEG 09 MIN 00 SEC E 9.30 FT TH N 04 DEG 36 MIN 00 SEC E 65.20 FT TH N 09 DEG 06 MIN 00 SEC E 38 FT TH N 05 DEG 10 MIN 30 SEC E 60.81 FT TH N 01 DEG 45 MIN 36 SEC E 118 FT M/L TO SH LN OF LK WASH & 2ND CL SH LNS ADJ</p>	<p>SCOPE OF WORK Lower level covered porch expansion, revised driveway configuration and new in-ground swimming pool & spa with terrace. No new conditioned space.</p> <p>AREA SUMMARY Conditioned Space Existing Lower Level 1,736 sq ft Existing Main Level 4,302 sq ft Existing Upper Level 3,092 sq ft New Upper Level-under Permit #1812-083 33 sq ft Total 9,153 sq ft</p> <p>AVERAGE BUILDING ELEVATION (ABE) DETERMINATION Refer to Detail 1, Sheet A-012</p> <p>GROSS FLOOR AREA (GFA) DIAGRAMS & SUMMARY Refer to Detail 2, Sheet A-012</p> <p>LOT COVERAGE & IMPERVIOUS SURFACES DIAGRAM Refer to Detail 2, Sheet A-013</p> <p>SHORELAND DEVELOPMENT STANDARDS DIAGRAM Refer to Detail 1, Sheet A-013</p>	<p>ENERGY CREDIT All work to comply with 2015 Washington State Energy Code (WSEC)</p> <ul style="list-style-type: none"> - Climate Zone: 4C (Marine) - Compliance Path: Mandatory & Prescriptive <p>ENERGY CODE DATA SHEET Refer to Table R402.1 and General Notes, Sheet A-01, for building envelope requirements.</p> <p>ADDITIONAL ENERGY EFFICIENCY REQUIREMENTS Per 2015 WSEC R406.2.2 Additional Energy efficiency requirements, no increase in conditioned space, thus no required energy efficiency requirements.</p>

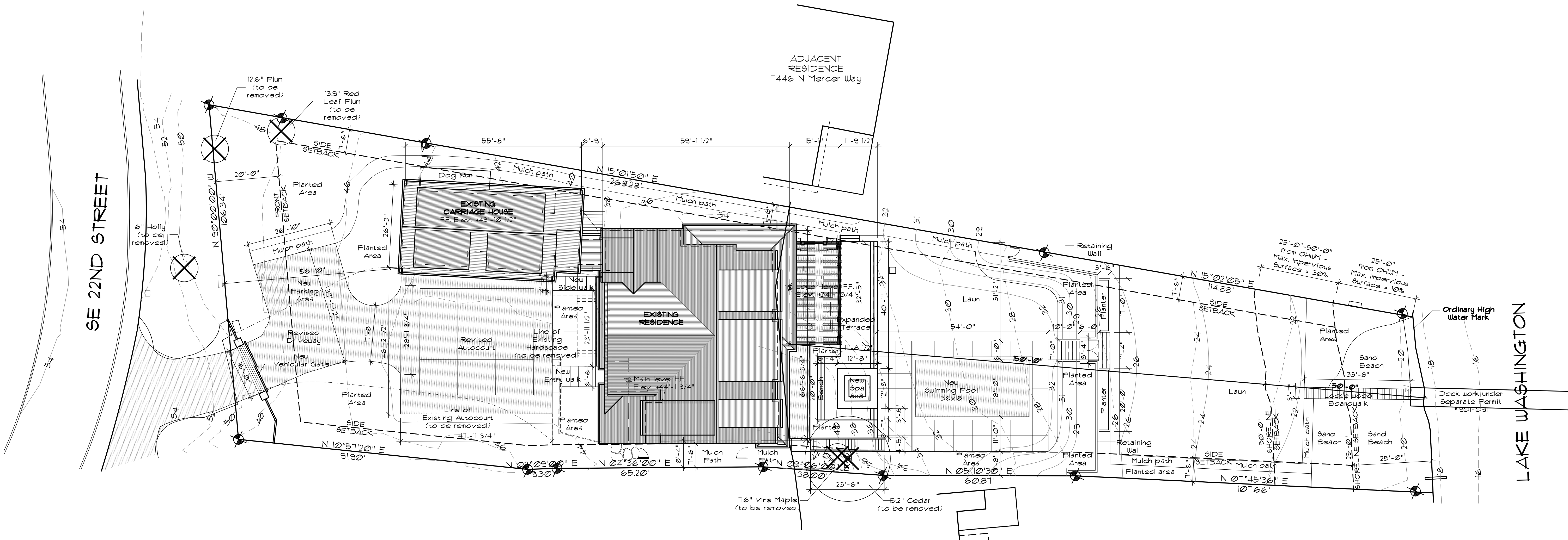

LEGEND	
SYMBOL	DESCRIPTION
---	CONTOUR - EXISTING
---	CONTOUR - PROPOSED
---	HARDSCAPE - HARDSCAPE (to be removed)

TREE INFORMATION
Site Plan only depicts trees proposed for removal (total of 5). Refer to Landscape Plan (L5-2.0 & L5-2.1), Planting Schedule & Notes (L5-2.2), Tree Inventory, Protection & Removal Plan (L5-1.0), and Survey for existing and proposed tree locations.

LANDSCAPING
Refer to Landscape Plan (L5-2.0 & L5-2.1) and Planting Schedule & Notes (L5-2.2) for details on planted areas, planters, pathways, and beach area.

DRAWN BY

DESIGN BY

CHECKED BY

APPROVED BY

DATE
April 1, 2019

REVISIONS

STILLWELL HANSON ARCHITECTS
46 ETRURIA STREET, SUITE 200
SEATTLE, WASHINGTON 98109
206 297 1504 PHONE
206 297 1543 FAX

LBH RESIDENCE
7450 NORTH MERCER WAY
MERCER ISLAND, WASHINGTON

7392 REGISTERED ARCHITECT
CRAIG J. STILLWELL
STATE OF WASHINGTON

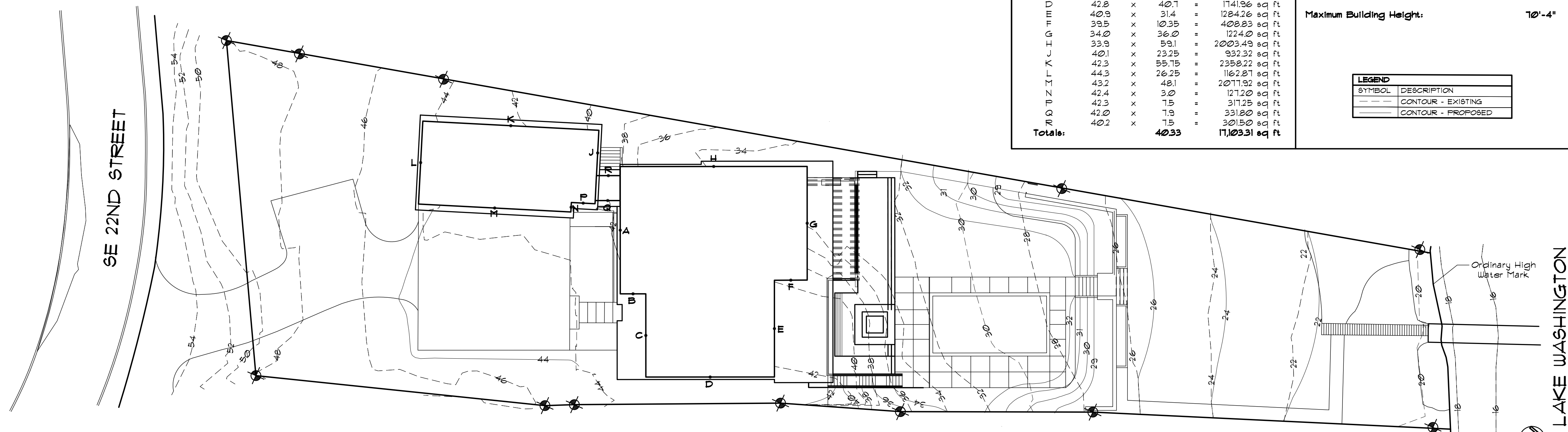

AVERAGE BUILDING ELEVATION (ABE) CALCULATIONS & HEIGHT LIMIT SUMMARY

MICC 19.02 E. 4.
Average building elevation (ABE) equals:
$$\frac{(\text{Mid-point Elevation of Individual Wall Segments}) \times (\text{Length of Individual Wall Segment})}{(\text{Total Length of Wall Segments})}$$

Mark	Elevation at Mid-Point	Length of Wall Segment	Product
A	41.6'	x 40.25'	= 1674.40 sq ft
B	42.2'	x 0.15'	= 31.65 sq ft
C	42.8'	x 26.3'	= 1125.64 sq ft
D	42.8'	x 40.7'	= 1741.96 sq ft
E	40.9'	x 31.4'	= 1284.26 sq ft
F	39.5'	x 10.35'	= 408.83 sq ft
G	34.0'	x 36.0'	= 1224.00 sq ft
H	33.9'	x 59.1'	= 2003.49 sq ft
I	40.1'	x 23.25'	= 932.32 sq ft
J	42.3'	x 55.15'	= 2350.22 sq ft
K	44.3'	x 26.25'	= 1162.87 sq ft
L	43.2'	x 48.1'	= 2077.92 sq ft
M	42.4'	x 3.0'	= 127.20 sq ft
N	42.3'	x 7.5'	= 317.25 sq ft
O	42.0'	x 7.9'	= 331.80 sq ft
P	40.2'	x 7.5'	= 301.50 sq ft
Totals:	40.33		17,103.31 sq ft

Average Building Elevation
 $17,103.31 \text{ sq ft} / 4241' = 40.33'$

Average Building Elevation (ABE): 40'-4"

BUILDING HEIGHT LIMIT SUMMARY
MIMC 19.02 E.1 Maximum building height shall not exceed 30 ft in height above the average building elevation (ABE).
Maximum Building Height
 $30 \text{ ft} + 40.33' (\text{ABE}) = 70.33'$

Maximum Building Height: 70'-4"

LEGEND

SYMBOL	DESCRIPTION
---	CONTOUR - EXISTING
---	CONTOUR - PROPOSED

1 ZONING DIAGRAM - Average Building Elevation (ABE) Determination
Scale 1" = 20'

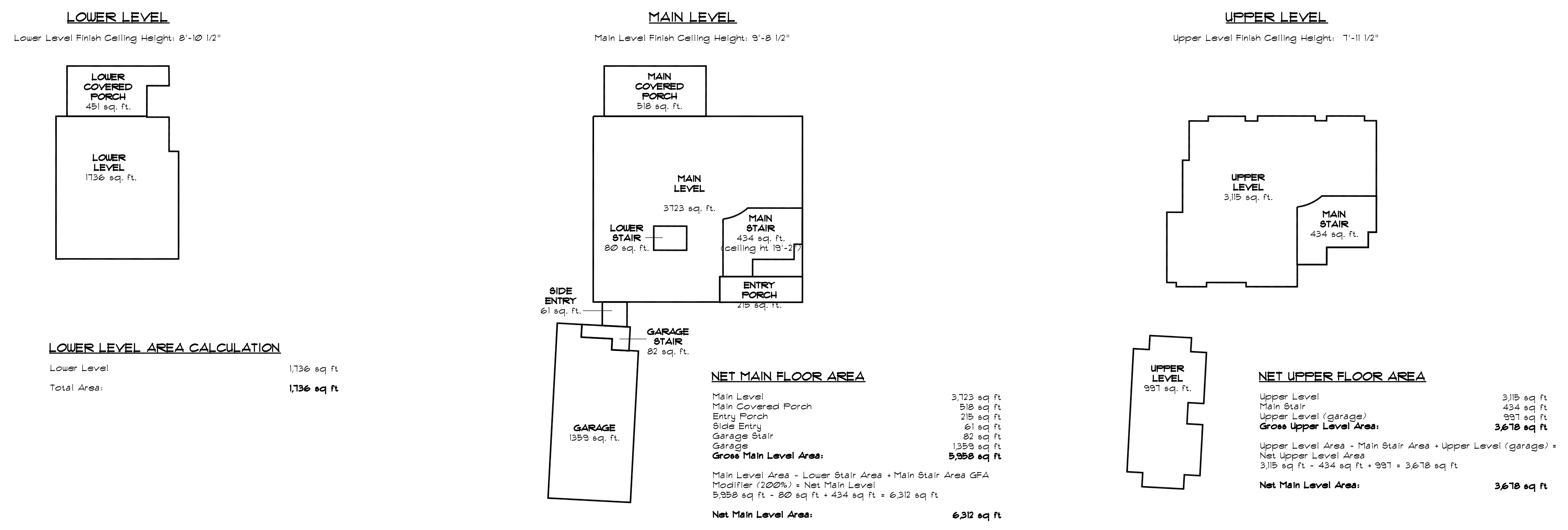

2 ZONING DIAGRAM - Gross Floor Area (GFA) Diagrams & Summary
Scale 1" = 20'

DRAWN BY
DESIGN BY
CHECKED BY
APPROVED BY
DATE
April 1, 2019
REVISIONS

STILLWELL HANSON ARCHITECTS
46 ETRURIA STREET, SUITE 200
SEATTLE, WASHINGTON 98109
206 297 1504 PHONE
206 297 1543 FAX

LBH RESIDENCE
7450 NORTH MERCER WAY
MERCER ISLAND, WASHINGTON

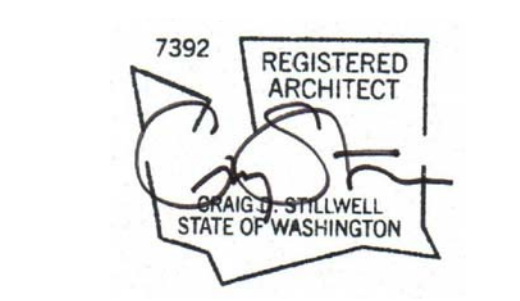

ZONING DIAGRAMS

A-1.2

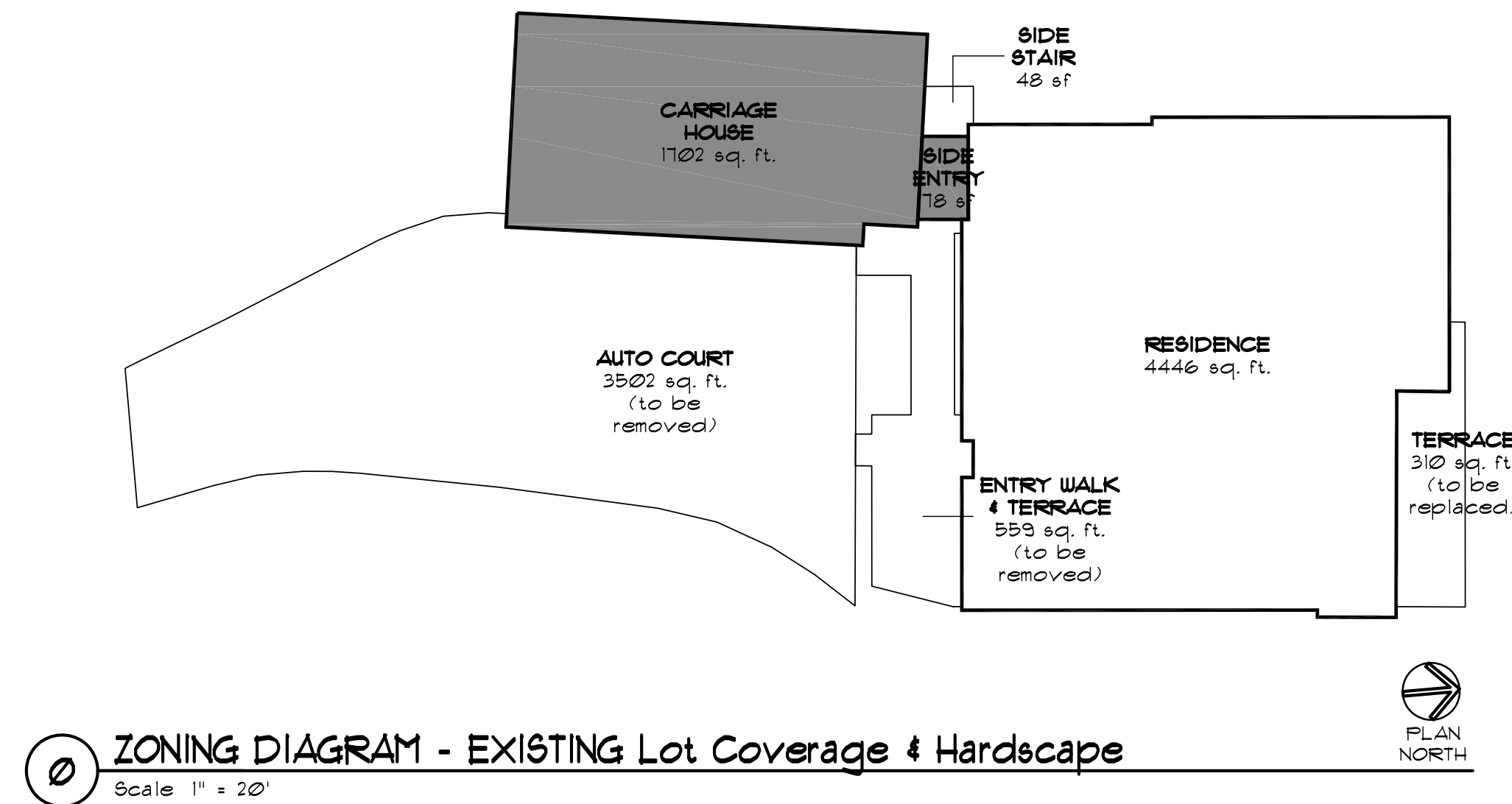

EXISTING LOT # HARDSCAPE COVERAGE	
EXISTING LOT # HARDSCAPE COVERAGE	
Lot Coverage	
Residence	4,446 sq. ft.
Side Entry	72 sq. ft.
Carriage House	1,702 sq. ft.
Auto Court	3,502 sq. ft.
Total	9,728 sq. ft.
TOTAL EXISTING LOT COVERAGE 9,728 sq. ft. / 30,945 sq. ft. = 31.4%	
Hardscape Coverage	
Side Stair	559 sq. ft.
Entry Walk & Terrace	147 sq. ft.
Terrace	310 sq. ft.
Total	1,016 sq. ft.
TOTAL EXISTING HARDSCAPE COVERAGE 1,016 sq. ft. / 30,945 sq. ft. = 3.3%	
TOTAL EXISTING COMBINED COVERAGE (Lot Coverage + Hardscape Coverage) 9,728 sq. ft. + 1,016 sq. ft. = 10,744 sq. ft. 10,744 sq. ft. / 30,945 sq. ft. = 34.7%	

1 ZONING DIAGRAM - EXISTING Lot Coverage & Hardscape
Scale 1" = 20'

SHORELINE DEVELOPMENT STANDARDS	
MICC 19.071 E. Shoreline Development Standards. Waterfront lot - Impervious surface limitations.	
0' to 25' Shoreline Setback	
Total Area = 1,462 sq. ft.	1,462 sq. ft.
Impervious Surface Limitation: 10% x 1,462 sq. ft.	
Impervious Surface Proposed:	
Boardwalk	72 sq. ft.
Total Impervious Surface Proposed:	72 sq. ft.
25' to 50' Shoreline Setback	
Total Area = 1,453 sq. ft.	435.9 sq. ft.
Impervious Surface Limitation: 30% x 1,453 sq. ft.	
Impervious Surface Proposed:	
Boardwalk	45 sq. ft.
Total Impervious Surface Proposed:	45 sq. ft.

PROPOSED LOT COVERAGE # HARDSCAPE CALCULATIONS	
MICC 19.02.020 F. 3. a. Lot Coverage - Landscaping Required. Minimum area required for single family dwelling shall provide the minimum landscaping area based on the net lot area and lot slope.	
LOT COVERAGE (Building & Driving Areas)	
Lot Slope:	8 %
Maximum Lot Coverage:	40 %
Landscaping Area Required:	60 %
Gross Lot Area:	30,945 sq. ft.
Net Lot Area:	30,945 sq. ft.
Maximum Lot Coverage 40 % x 30,945 sq. ft. = 12,378 sq. ft.	
Required Landscaping Area 60 % x 30,945 sq. ft. = 18,567 sq. ft.	
HARDSCAPE COVERAGE	
Lot Slope:	8 %
Maximum Lot Coverage:	9 %
Net Lot Area:	30,945 sq. ft.
9 % x 30,945 sq. ft.:	2,785 sq. ft.
TOTAL COMBINED COVERAGE ALLOWED (Lot Coverage + Hardscape Coverage) 12,378 sq. ft. + 2,785 sq. ft. = 15,163 sq. ft. / 30,945 sq. ft. = 49%	
PROPOSED LOT # HARDSCAPE COVERAGE	
Lot Coverage	
Residence	4,680 sq. ft.
Side Entry	78 sq. ft.
Carriage House	1,702 sq. ft.
Auto Court	2,069 sq. ft.
Driveway & Parking	1,508 sq. ft.
Total	10,037 sq. ft.
TOTAL PROPOSED LOT COVERAGE 10,037 sq. ft. / 30,945 sq. ft. = 32.4%	
Hardscape Coverage	
Pool & Terrace	1,879 sq. ft.
Covered Porch Terrace	906 sq. ft.
Spa	160 sq. ft.
Pool Stair	104 sq. ft.
Lower Walk & Stair	157 sq. ft.
Beach Walk	117 sq. ft.
Side Entry Walk	78 sq. ft.
Entry Walk	116 sq. ft.
Total	3,517 sq. ft.
TOTAL PROPOSED HARDSCAPE COVERAGE 3,517 sq. ft. / 30,945 sq. ft. = 11.4%	
TOTAL PROPOSED COMBINED COVERAGE (Lot Coverage + Hardscape Coverage) 10,037 sq. ft. + 3,517 sq. ft. = 13,554 sq. ft. / 30,945 sq. ft. = 43.8%	

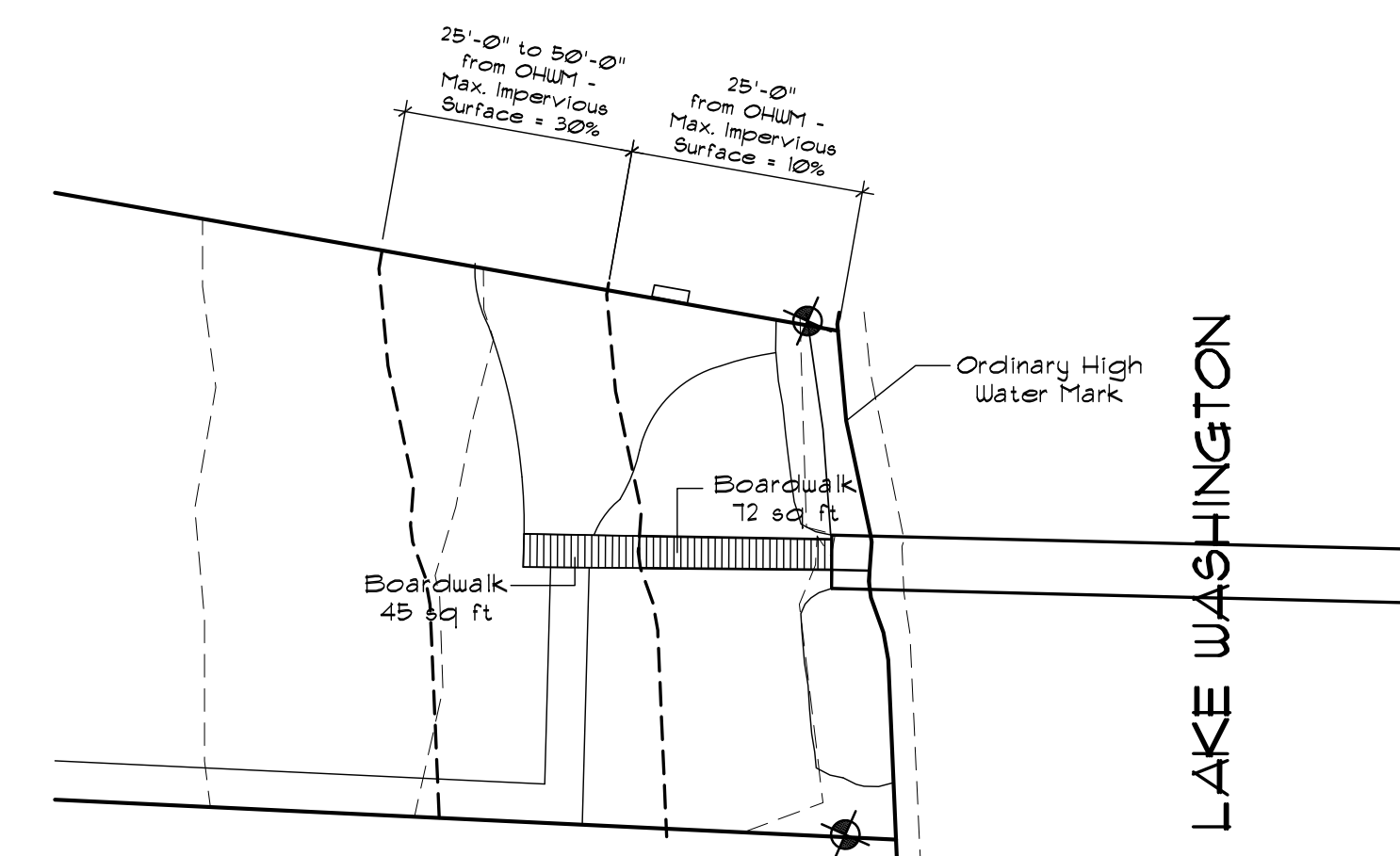

1 ZONING DIAGRAM - PROPOSED Shoreline Development
Not to Scale

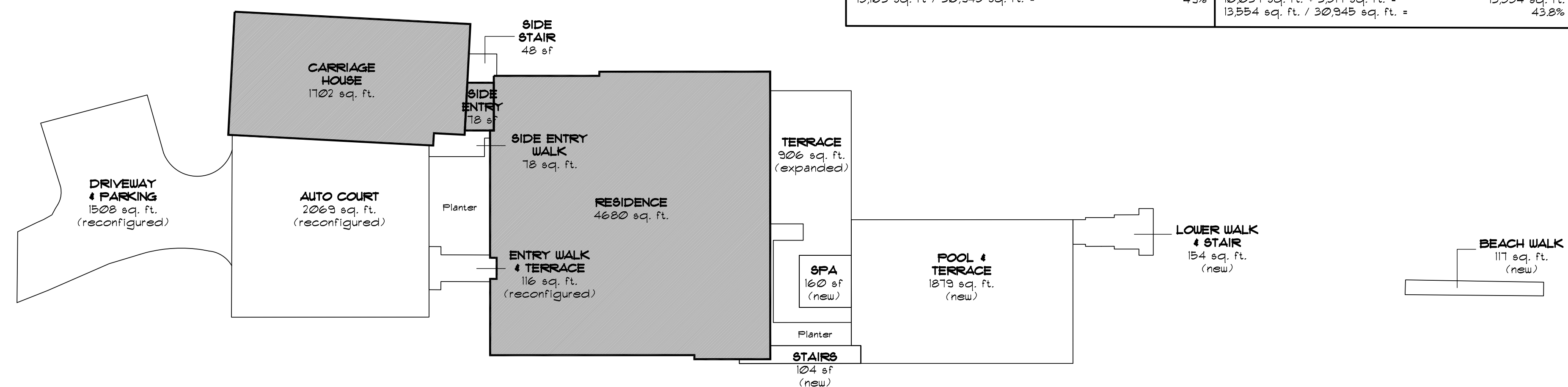

2 ZONING DIAGRAM - PROPOSED Lot Coverage & Hardscape
Scale 1" = 20'

DRAWN BY
DESIGN BY
CHECKED BY
APPROVED BY

DATE
April 1, 2019

REVISIONS

STILLWELL HANSON ARCHITECTS
46 ETRURIA STREET, SUITE 200
SEATTLE, WASHINGTON 98109
206 297 1504 PHONE
206 297 1543 FAX

LBH RESIDENCE
7450 NORTH MERCER WAY
MERCER ISLAND, WASHINGTON

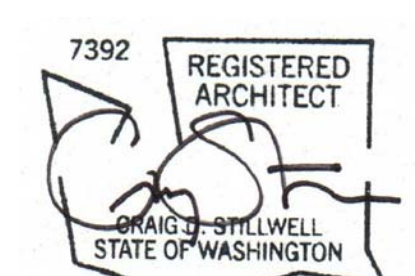

ZONING DIAGRAMS

A-1.3

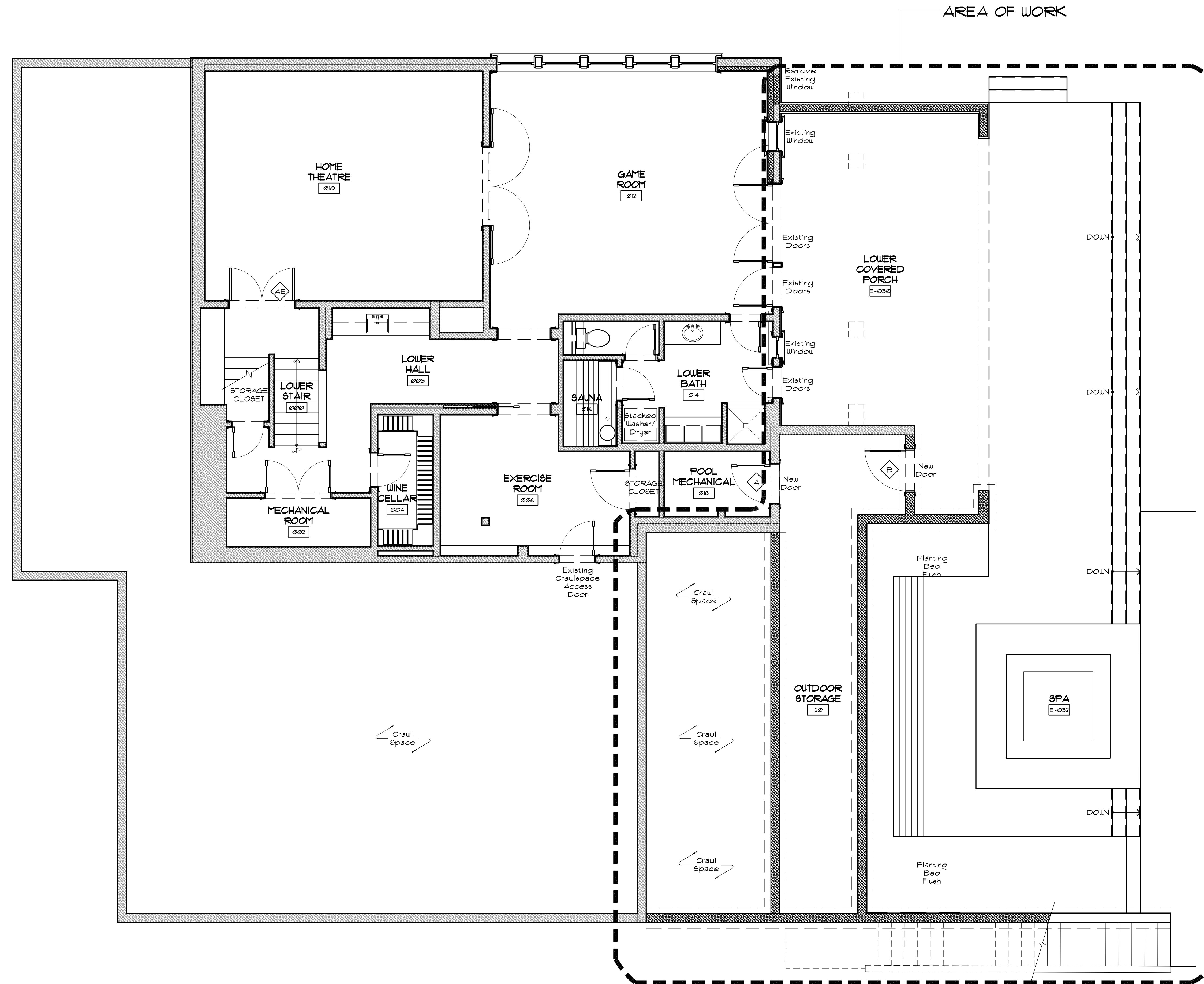

FLOOR PLAN LEGEND

SYMBOL	DESCRIPTION
	New Walls to be Constructed
	Existing Walls to Remain
	Existing Walls to be Demolished

DRAWN BY

DESIGN BY

CHECKED BY

APPROVED BY

DATE

April 1, 2019

REVISIONS

STILLWELL HANSON ARCHITECTS

46 ETRURIA STREET, SUITE 200
SEATTLE, WASHINGTON 98109
206 297 1504 PHONE
206 297 1543 FAX

LBH RESIDENCE

7450 NORTH MERCER WAY
MERCER ISLAND, WASHINGTON

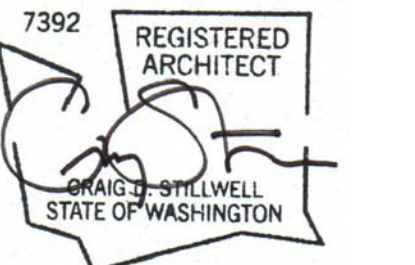

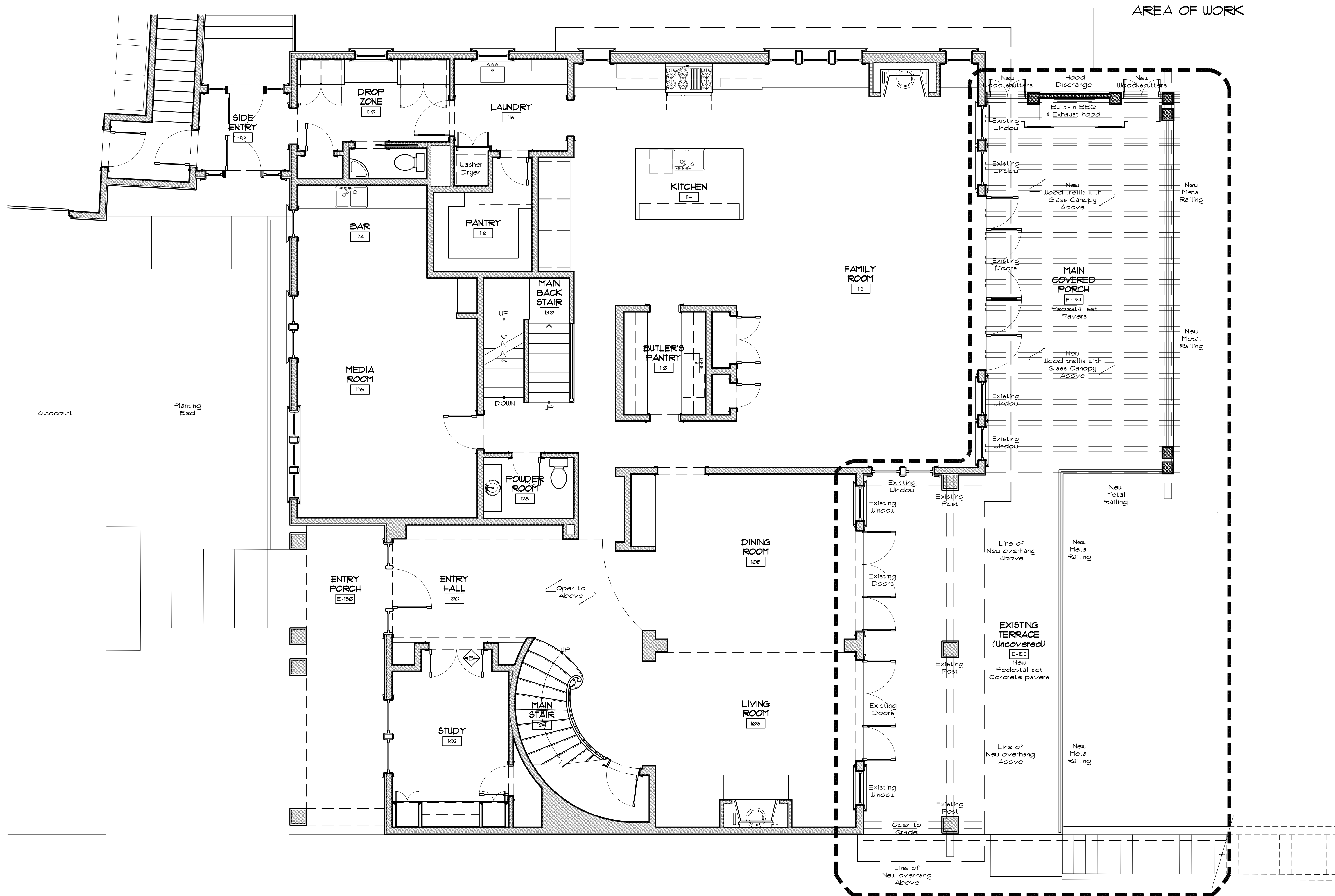

FLOOR PLAN LEGEND

SYMBOL	DESCRIPTION
	New Walls to be Constructed
	Existing Walls to Remain
	Existing Walls to be Demolished

DRAWN BY

DESIGN BY

CHECKED BY

APPROVED BY

DATE

April 1, 2019

REVISIONS

STILLWELL HANSON ARCHITECTS

46 ETRURIA STREET, SUITE 200
SEATTLE, WASHINGTON 98109
206 297 1504 PHONE
206 297 1543 FAX

LBH RESIDENCE

7450 NORTH MERCER WAY
MERCER ISLAND, WASHINGTON

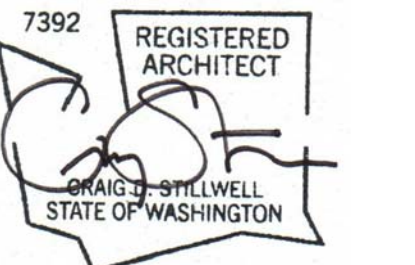

**FLOOR PLAN
MAIN LEVEL**

A-2.2



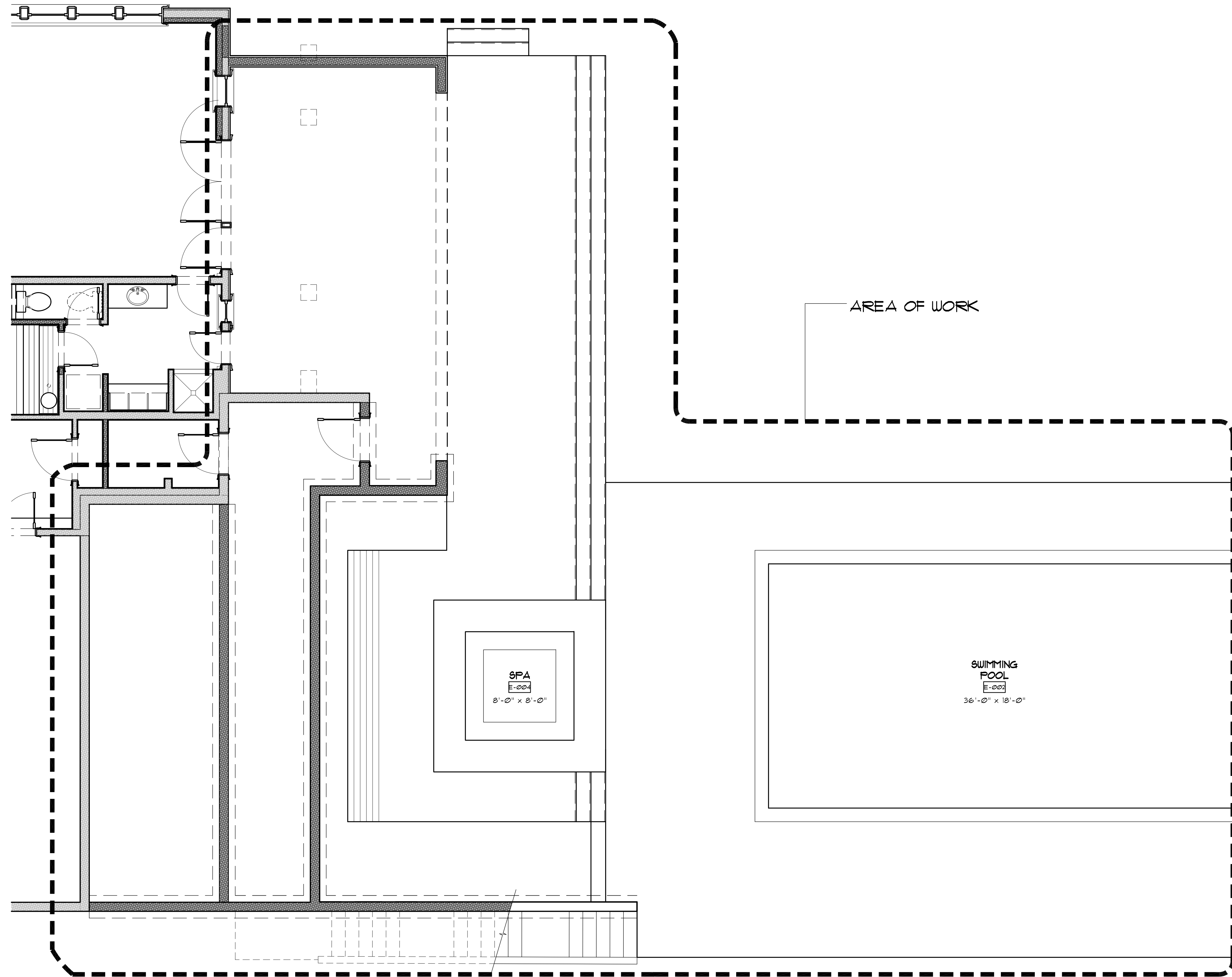

FLOOR PLAN LEGEND

SYMBOL	DESCRIPTION
	New Walls to be Constructed
	Existing Walls to Remain
	Existing Walls to be Demolished

DRAWN BY

DESIGN BY

CHECKED BY

APPROVED BY

DATE

April 1, 2019

REVISIONS

STILLWELL HANSON ARCHITECTS

46 ETRURIA STREET, SUITE 200
SEATTLE, WASHINGTON 98109
206 297 1504 PHONE
206 297 1543 FAX

LBH RESIDENCE

7450 NORTH MERCER WAY
MERCER ISLAND, WASHINGTON

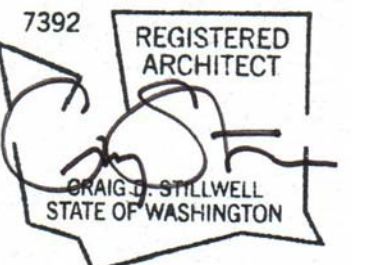

**FLOOR PLAN
POOL TERRACE**

A-2.5





1 EXTERIOR ELEVATION - North
Scale 1/4" = 1'-0"



2 EXTERIOR ELEVATION - South
Scale 1/4" = 1'-0"

DRAWN BY
DESIGN BY
CHECKED BY
APPROVED BY

DATE
December 1, 2018

REVISIONS
CORRECTION #1
February 1, 2019

**STILLWELL HANSON
ARCHITECTS**

46 ETRURIA STREET, SUITE 200
SEATTLE, WASHINGTON 98109
206 297 1504 PHONE
206 297 1543 FAX

**LBH
RESIDENCE**

7450 NORTH MERCER WAY
MERCER ISLAND, WASHINGTON

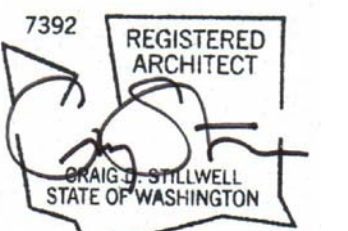

EXTERIOR
ELEVATIONS

A-3.1



1 EXTERIOR ELEVATION - West
Scale 1/4" = 1'-0"



2 EXTERIOR ELEVATION - East
Scale 1/4" = 1'-0"

DRAWN BY
DESIGN BY
CHECKED BY
APPROVED BY
DATE
April 1, 2019

REVISIONS

STILLWELL HANSON
ARCHITECTS

46 ETRURIA STREET, SUITE 200
SEATTLE, WASHINGTON 98109
206 297 1504 PHONE
206 297 1543 FAX

LBH
RESIDENCE

7450 NORTH MERCER WAY
MERCER ISLAND, WASHINGTON

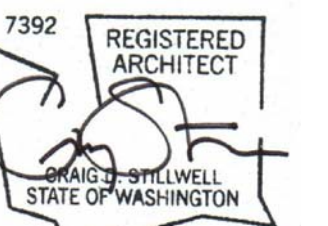

EXTERIOR
ELEVATIONS

A-3.2

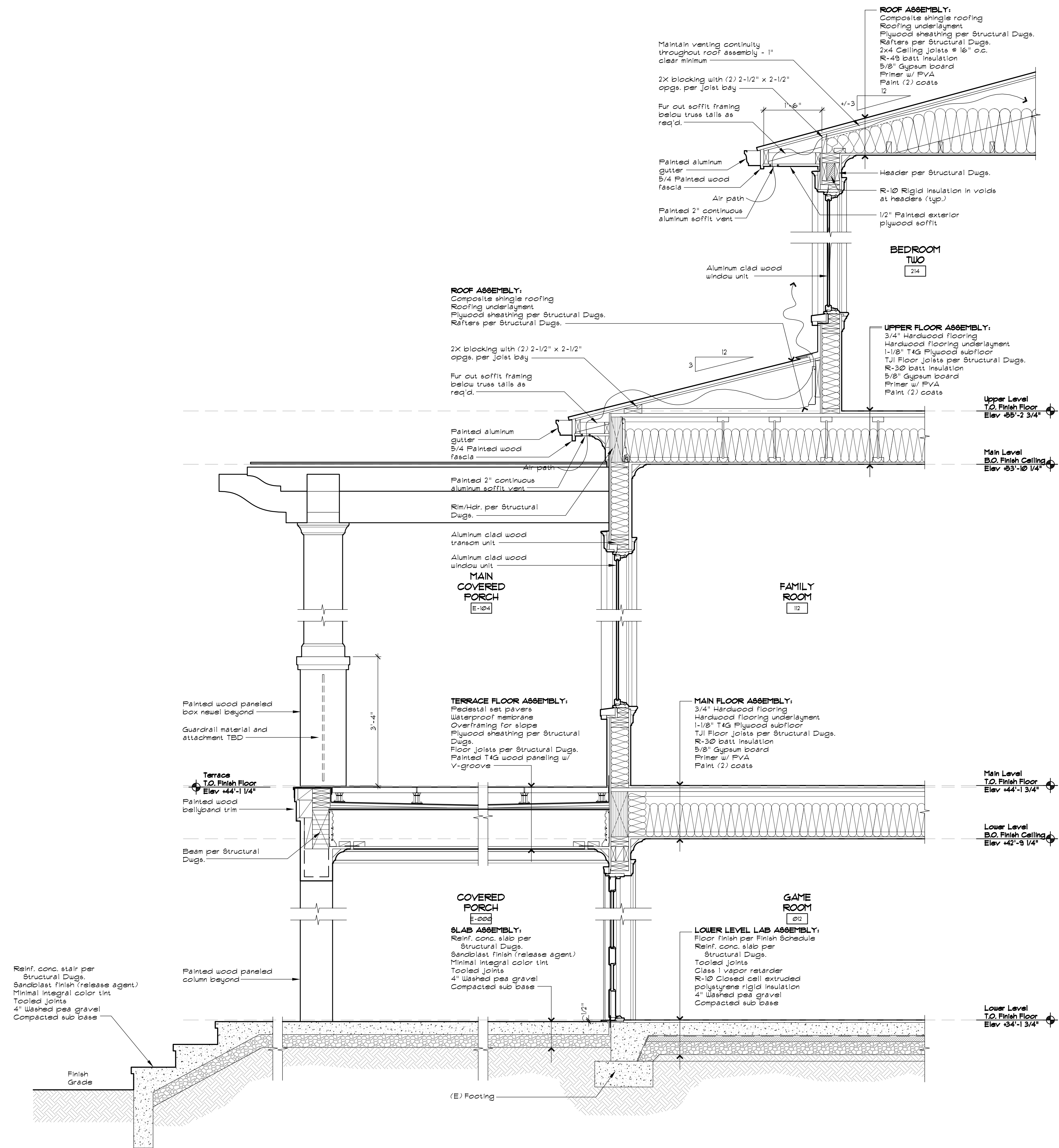

1 WALL SECTION
Scale 3/4" = 1'-0"

DRAWN BY
DESIGN BY
CHECKED BY
APPROVED BY
DATE
April 1, 2019
REVISIONS

STILLWELL HANSON ARCHITECTS

46 ETRURIA STREET, SUITE 200
SEATTLE, WASHINGTON 98109
206 297 1504 PHONE
206 297 1543 FAX

LBH RESIDENCE

7450 NORTH MERCER WAY
MERCER ISLAND, WASHINGTON

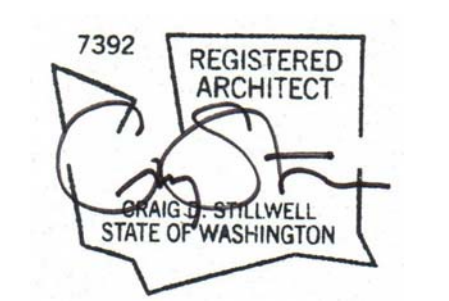

WALL SECTIONS

A-4.1

DOOR DIAGRAM NOTES

1. Exterior doors are shown from the exterior side.
2. General Contractor to confirm all rough opening requirements and installation requirements with manufacturer.
3. Manufacturer to review installation locations and confirm safety glazing requirements.
4. Manufacturer to review installation locations and confirm designated units meet egress requirements.
5. Install units per all manufacturer's recommendations.
6. CONTRACTOR TO PROVIDE SHOP DRAWINGS FOR APPROVAL BY ARCHITECT PRIOR TO FABRICATION.

DOOR SPEC

MANUFACTURER & MODEL:
Fella or approved equal

EXTERIOR & INTERIOR COLOR:
Match "Standard White" (verify)

GLASS:
Low E

HARDWARE
TBD

DIVIDED LITE:
Match existing size & profile

LEGEND	
TG	Tempered Glass
B	Door Butt
RC	Roller Catch

DRAWN BY

DESIGN BY

CHECKED BY

APPROVED BY

DATE
April 1, 2019

REVISIONS

EXTERIOR DOOR SCHEDULE

SYMBOL	LOCATION	ROOM	DIAGRAM	TYPE	SIZE	AREA	FINISH	U	REMARKS
A	Pool Mechanical	06	A below	Ext.	See diagram	NA	Ftd / Ftd	NA	
B	Outdoor Storage	E-006	B below	Ext.	See diagram	NA	Ftd / Ftd	NA	

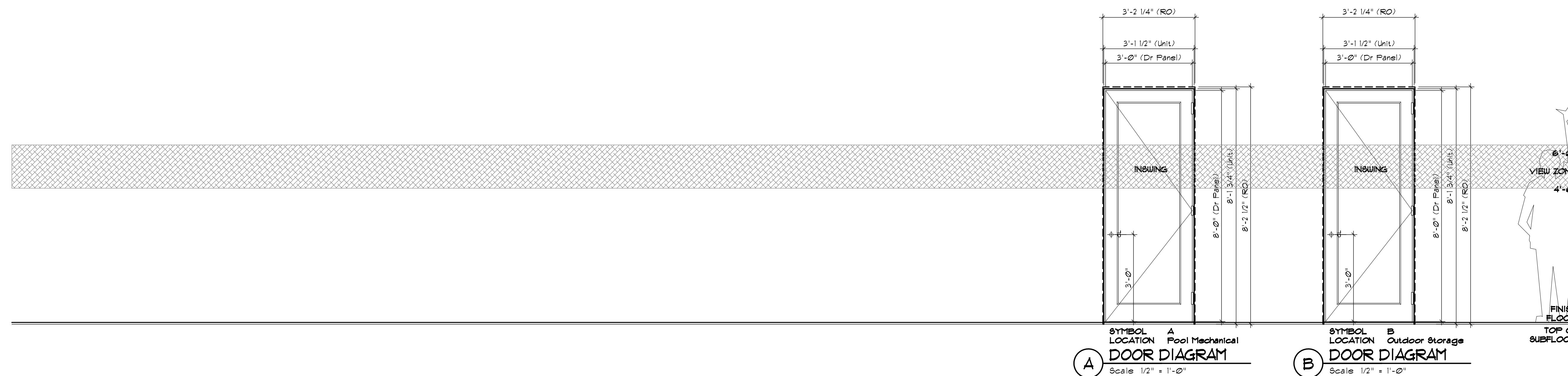

STILLWELL HANSON ARCHITECTS

46 ETRURIA STREET, SUITE 200
 SEATTLE, WASHINGTON 98109
 206 297 1504 PHONE
 206 297 1543 FAX

LBH RESIDENCE

7450 NORTH MERCER WAY
 MERCER ISLAND, WASHINGTON

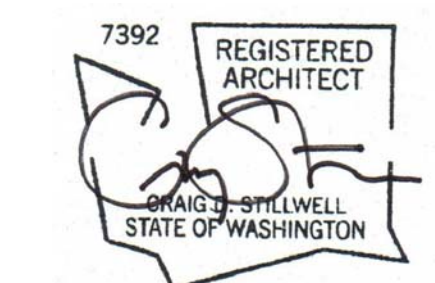

EXTERIOR DOOR SCHEDULE

A-5.1

SE 1/4 OF SW 1/4 SEC. 1, TWN. 24N, RGE. 4E, W.M.

WA DOE SOIL AMENDMENT NOTES

SOIL RETENTION RETAIN, IN AN UNDISTURBED STATE, THE DUFF LAYER AND NATIVE TOPSOIL TO THE MAXIMUM EXTENT PRACTICABLE, IN ANY AREAS REQUIRING GRADING REMOVE AND STOCKPILE THE DUFF LAYER AND TOPSOIL ON SITE IN A DESIGNATED, CONTROLLED AREA, NOT ADJACENT TO PUBLIC RESOURCES AND CRITICAL AREAS, TO BE REAPPLIED TO OTHER PORTIONS OF THE SITE WHERE FEASIBLE.

SOIL QUALITY ALL AREAS SUBJECT TO CLEARING AND GRADING THAT HAVE NOT BEEN COVERED BY IMPERVIOUS SURFACE, INCORPORATED INTO A DRAINAGE FACILITY OR ENGINEERED AS STRUCTURAL FILL OR SLOPE SHALL, AT PROJECT COMPLETION, DEMONSTRATE THE FOLLOWING:

- A TOPSOIL LAYER WITH A MINIMUM ORGANIC MATTER CONTENT OF 10% DRY WEIGHT IN PLANTING BEDS, AND 5% ORGANIC MATTER CONTENT IN TURF AREAS, AND A PH FROM 6.0 TO 8.0 OR MATCHING THE PH OF THE UNDISTURBED SOIL. THE TOPSOIL LAYER SHALL HAVE A MINIMUM DEPTH OF 6 INCHES EXCEPT WHERE TREE ROOTS LIMIT THE DEPTH OF INCORPORATION OF AMENDMENTS NEEDED TO MEET THE CRITERIA. SUBSOILS BELOW THE TOPSOIL LAYER SHOULD BE SCARIFIED AT LEAST 4 INCHES WITH SOME INCORPORATION OF THE UPPER MATERIAL TO AVOID STRATIFIED LAYERS, WHERE FEASIBLE.
- MULCH PLANTING BEDS WITH 2 INCHES OF ORGANIC MATERIAL.
- USE COMPOST AND OTHER MATERIALS THAT MEET THESE ORGANIC CONTENT REQUIREMENTS.
 - THE COMPOST MUST ALSO HAVE AN ORGANIC MATTER CONTENT OF 40% TO 65%, AND A CARBON TO NITROGEN RATIO BELOW 25:1. THE CARBON TO NITROGEN RATIO MAY BE AS HIGH AS 35:1 FOR PLANTINGS COMPOSED ENTIRELY OF PLANTS NATIVE TO THE PUGET SOUND LOWLANDS REGION.
 - CALCULATED AMENDMENT RATES MAY BE MET THROUGH USE OF COMPOSTED MATERIALS MEETING (A) ABOVE, OR OTHER ORGANIC MATERIALS AMENDED TO MEET THE CARBON TO NITROGEN RATIO REQUIREMENTS, AND MEETING THE CONTAMINANT STANDARDS OF GRADE A COMPOST.

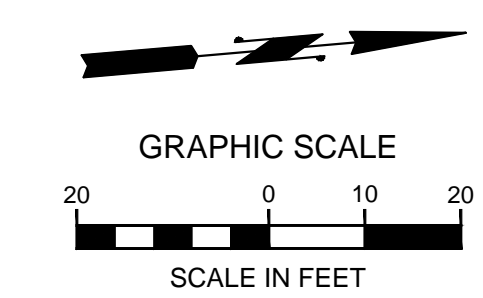
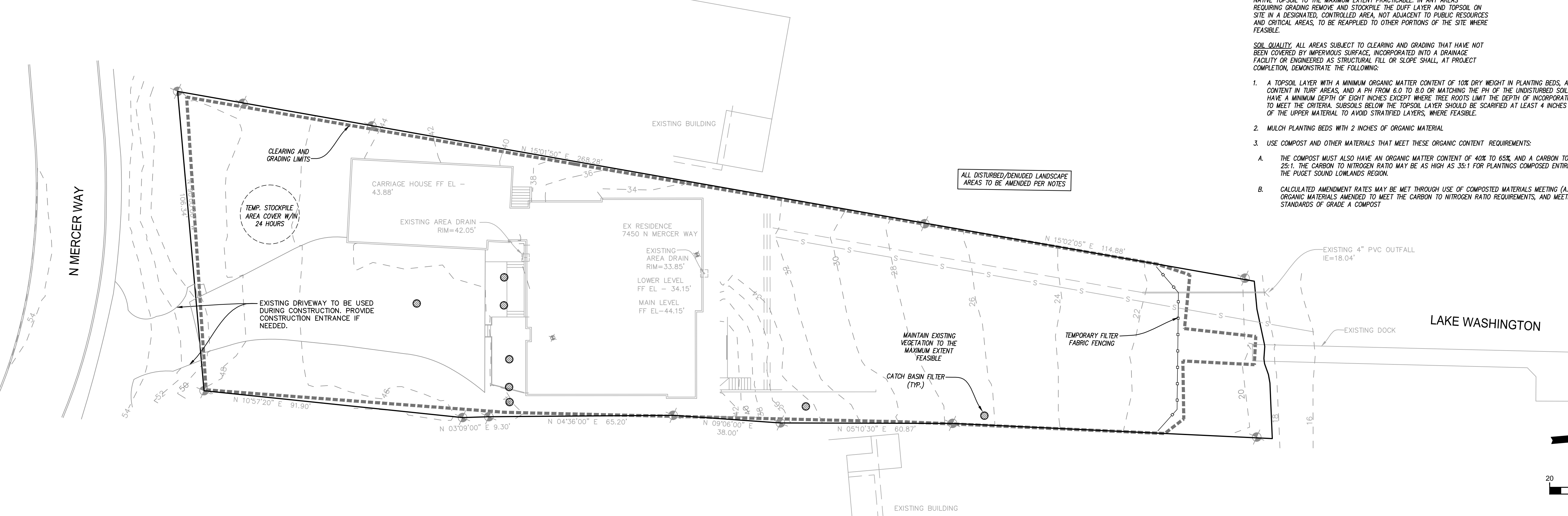

EROSION & SEDIMENT CONTROL NOTES

- APPROVAL OF THIS EROSION/SEDIMENTATION CONTROL (ESC) PLAN DOES NOT CONSTITUTE AN APPROVAL OF PERMANENT ROAD OR DRAINAGE DESIGN (E.G., SIZE AND LOCATION OF ROADS, PIPES, RESTRICTORS, CHANNELS, RETENTION FACILITIES, UTILITIES, ETC.).
- THE IMPLEMENTATION OF THIS ESC PLAN AND THE CONSTRUCTION, MAINTENANCE, REPLACEMENT, AND UPGRADING OF THESE ESC FACILITIES IS THE RESPONSIBILITY OF THE PERMITTEE/CONTRACTOR UNTIL ALL CONSTRUCTION IS APPROVED.
- THE BOUNDARIES OF THE CLEARING LIMITS SHOWN ON THIS PLAN SHALL BE SET BY SURVEY AND CLEARLY FLAGGED IN THE FIELD BY A CLEARING CONTROL FENCE PRIOR TO CONSTRUCTION. DURING THE CONSTRUCTION PERIOD NO DISTURBANCE OR REMOVAL OF ANY GRASS COVER BEYOND THE FLAGGED CLEARING LIMITS SHALL BE PERMITTED. THE FLAGGING SHALL BE MAINTAINED BY THE PERMITTEE/CONTRACTOR FOR THE DURATION OF CONSTRUCTION.
- THE ESC FACILITIES SHOWN ON THIS PLAN MUST BE CONSTRUCTED PRIOR TO OR IN CONJUNCTION WITH ALL CLEARING AND GRADING ACTIVITIES IN SUCH A MANNER AS TO ENSURE THAT SEDIMENT-LADEN WATER DOES NOT ENTER THE DRAINAGE SYSTEM OR VIOLATE APPLICABLE WATER STANDARDS. WHEREVER POSSIBLE, MAINTAIN NATURAL VEGETATION FOR SILT CONTROL.
- THE ESC FACILITIES SHOWN ON THIS PLAN ARE THE MINIMUM REQUIREMENTS FOR ANTICIPATED SITE CONDITIONS. DURING THE CONSTRUCTION PERIOD, THESE ESC FACILITIES SHALL BE UPGRADED (E.G., ADDITIONAL SUMPS, RELOCATION OF DITCHES AND SILT FENCES, ETC.) AS NEEDED FOR UNEXPECTED STORM EVENTS. ADDITIONALLY, MORE ESC FACILITIES MAY BE REQUIRED TO ENSURE COMPLETE SILTATION CONTROL. THEREFORE, DURING THE COURSE OF CONSTRUCTION IT SHALL BE THE OBLIGATION AND RESPONSIBILITY OF THE CONTRACTOR TO ADDRESS ANY NEW CONDITIONS THAT MAY BE CREATED BY HIS ACTIVITIES AND TO PROVIDE ADDITIONAL FACILITIES OVER AND ABOVE THE MINIMUM REQUIREMENTS AS MAY BE NEEDED.
- THE ESC FACILITIES SHALL BE INSPECTED BY THE PERMITTEE/CONTRACTOR DAILY DURING NON-RAINFALL PERIODS, EVERY HOUR (DAYLIGHT) DURING A RAINFALL EVENT, AND AT THE END OF EVERY RAINFALL, AND MAINTAINED AS NECESSARY TO ENSURE THEIR CONTINUED FUNCTIONING. IN ADDITION, TEMPORARY SILTATION PONDS AND ALL TEMPORARY SILTATION CONTROLS SHALL BE MAINTAINED IN A SATISFACTORY CONDITION UNTIL SUCH TIME THAT CLEARING AND/OR CONSTRUCTION IS COMPLETED, PERMANENT DRAINAGE FACILITIES ARE OPERATIONAL, AND THE POTENTIAL FOR EROSION HAS PASSED. WRITTEN RECORDS SHALL BE KEPT DOCUMENTING THE REVIEWS OF THE ESC FACILITIES.
- THE ESC FACILITIES ON INACTIVE SITES SHALL BE INSPECTED AND MAINTAINED A MINIMUM OF ONCE A MONTH OR WITHIN 48 HOURS FOLLOWING A STORM EVENT.
- ALL DENUDE SOILS MUST BE STABILIZED WITH AN APPROVED TESC METHOD (E.G. SEEDING, MULCHING, PLASTIC COVERING, CRUSHED ROCK) WITHIN THE FOLLOWING TIMELINES:
 - * APRIL 1 TO OCTOBER 31 - SOILS MUST BE STABILIZED WITHIN 7 DAYS OF GRADING.
 - * NOVEMBER 1 TO MARCH 31 - SOILS MUST BE STABILIZED WITHIN 2 DAYS OF GRADING.
- AT NO TIME SHALL MORE THAN 1" OF SEDIMENT BE ALLOWED TO ACCUMULATE WITHIN A CATCH BASIN. ALL CATCH BASINS AND CONVEYANCE LINES SHALL BE CLEANED PRIOR TO PAVING. THE CLEANING OPERATION SHALL NOT FLUSH SEDIMENT INTO THE DOWNSTREAM SYSTEM.
- STABILIZED CONSTRUCTION ENTRANCES SHALL BE INSTALLED AT THE BEGINNING OF CONSTRUCTION AND MAINTAINED FOR THE DURATION OF THE PROJECT. ADDITIONAL MEASURES, SUCH AS WASH PADS, MAY BE REQUIRED TO ENSURE THAT ALL PAVED AREAS ARE KEPT CLEAN FOR THE DURATION OF THE PROJECT.
- ANY PERMANENT RETENTION FACILITY USED AS A TEMPORARY SETTLING BASIN SHALL BE MODIFIED WITH THE NECESSARY EROSION CONTROL MEASURES AND SHALL PROVIDE ADEQUATE STORAGE CAPACITY. IF THE PERMANENT FACILITY IS TO FUNCTION ULTIMATELY AS AN INFILTRATION OR DISPERSION SYSTEM, THE FACILITY SHALL NOT BE USED AS A TEMPORARY SETTLING BASIN. NO UNDERGROUND DETENTION TANK, DETENTION VAULT, OR SYSTEM WHICH BACKS UNDER OR INTO A POND SHALL BE USED AS A TEMPORARY SETTLING BASIN.
- WHERE SEEDING FOR TEMPORARY EROSION CONTROL IS REQUIRED, FAST GERMINATING GRASSES SHALL BE APPLIED AT AN APPROPRIATE RATE (EXAMPLE: ANNUAL OR PERENNIAL RYE APPLIED AT APPROXIMATELY 80 POUNDS PER ACRE).
- WHERE STRAW MULCH IS REQUIRED FOR TEMPORARY EROSION CONTROL, IT SHALL BE APPLIED AT A MINIMUM THICKNESS OF 2".
- ALL EROSION/SEDIMENTATION CONTROL PONDS WITH A DEAD STORAGE DEPTH EXCEEDING 6" MUST HAVE A PERIMETER FENCE WITH A MINIMUM HEIGHT OF 3'.
- ALL WORK AND MATERIALS SHALL BE IN ACCORDANCE WITH CITY OF MERCEUR ISLAND STANDARDS AND SPECIFICATIONS.
- THE ESC FACILITIES SHALL BE CONSTRUCTED IN ACCORDANCE WITH THE DETAILS ON THE APPROVED PLANS. LOCATIONS MAY BE MOVED TO SUIT FIELD CONDITIONS, SUBJECT TO APPROVAL BY THE ENGINEER AND THE CITY OF MERCEUR ISLAND INSPECTOR.
- A COPY OF THE APPROVED EROSION CONTROL PLANS MUST BE ON THE JOB SITE WHENEVER CONSTRUCTION IS IN PROGRESS.
- ALL LOTS ADJOINING OR HAVING ANY NATIVE GROWTH PROTECTION EASEMENTS (NGPE) SHALL HAVE A 4' HIGH TEMPORARY CONSTRUCTION FENCE (CYCLONE OR PLASTIC MESH) SEPARATING THE LOT (OR BUILDABLE PORTIONS OF THE LOT) FROM THE AREA RESTRICTED BY THE NGPE AND SHALL BE INSTALLED PRIOR TO ANY GRADING OR CLEARING AND REMAIN IN PLACE UNTIL A DWELLING IS CONSTRUCTED AND OWNERSHIP TRANSFERRED TO THE FIRST OWNER/OCCUPANT.
- CLEARING LIMITS SHALL BE DELINEATED WITH A CLEARING CONTROL FENCE. THE CLEARING CONTROL FENCE SHALL CONSIST OF A 6-FT. HIGH CHAIN LINK FENCE ADJACENT TO THE DRAIN LINE OF TREES TO BE SAVED, WETLAND OR STREAM BUFFERS, AND SENSITIVE SLOPES. CLEARING CONTROL FENCES ALONG WETLAND OR STREAM BUFFERS OR UPSLOPE OF SENSITIVE SLOPES SHALL BE ACCOMPANIED BY AN EROSION CONTROL FENCE. IF APPROVED BY THE CITY, A FOUR-FOOT HIGH ORANGE MESH CLEARING CONTROL FENCE MAY BE USED TO DELINEATE CLEARING LIMITS IN ALL OTHER AREAS.
- OFF-SITE STREETS MUST BE KEPT CLEAN AT ALL TIMES. IF DIRT IS DEPOSITED ON THE PUBLIC STREET SYSTEM, THE STREET SHALL BE IMMEDIATELY CLEANED WITH POWER SWEEPER OR OTHER EQUIPMENT. ALL VEHICLES SHALL LEAVE THE SITE BY WAY OF THE CONSTRUCTION ENTRANCE AND SHALL BE CLEANED OF ALL DIRT THAT WOULD BE DEPOSITED ON THE PUBLIC STREETS.
- ANY CATCH BASINS COLLECTING RUNOFF FROM THE SITE, WHETHER THEY ARE ON OR OFF THE SITE, SHALL HAVE THEIR GRATES COVERED WITH FILTER FABRIC DURING CONSTRUCTION. CATCH BASINS DIRECTLY DOWNSTREAM OF THE CONSTRUCTION ENTRANCE OR ANY OTHER CATCH BASIN AS DETERMINED BY THE CITY INSPECTOR SHALL BE PROTECTED WITH A "FILTER FABRIC SOCK" OR EQUIVALENT.
- THE WASHED GRAVEL BACKFILL ADJACENT TO THE FILTER FABRIC FENCE SHALL BE REPLACED AND THE FILTER FABRIC CLEANED IF IT IS NONFUNCTIONAL BY EXCESSIVE SILT ACCUMULATION AS DETERMINED BY THE CITY OF KIRKLAND. ALSO, ALL INTERCEPTOR SWALES SHALL BE CLEANED IF SILT ACCUMULATION EXCEEDS ONE-QUARTER DEPTH.
- ROCK FOR EROSION PROTECTION OF ROADWAY DITCHES, WHERE REQUIRED, MUST BE OF SOUND QUARRY ROCK, PLACED TO A DEPTH OF 1' AND MUST MEET THE FOLLOWING SPECIFICATIONS: 4"-8" ROCK/40%-70% PASSING; 2"-4" ROCK/30%-40% PASSING; AND 1"-2" ROCK/10%-20% PASSING.
- IF ANY PART(S) OF THE CLEARING LIMIT BOUNDARY OR TEMPORARY EROSION/SEDIMENTATION CONTROL PLAN IS/ARE DAMAGED, IT SHALL BE REPAIRED IMMEDIATELY.
- ALL PROPERTIES ADJACENT TO THE PROJECT SITE SHALL BE PROTECTED FROM SEDIMENT DEPOSITION AND RUNOFF.
- DO NOT FLUSH CONCRETE BY-PRODUCTS OR TRUCKS NEAR OR INTO THE STORM DRAINAGE SYSTEM. IF EXPOSED AGGREGATE IS FLUSHED INTO THE STORM SYSTEM, IT COULD MEAN RE-CLEANING THE ENTIRE DOWNSTREAM STORM SYSTEM, OR POSSIBLY RE-LAYING THE STORM LINE.
- PRIOR TO OCTOBER 1 OF EACH YEAR (THE BEGINNING OF THE WET SEASON), ALL DISTURBED AREAS SHALL BE REVIEWED TO IDENTIFY WHICH ONES CAN BE SEEDED IN PREPARATION FOR THE WINTER RAINS. THE IDENTIFIED DISTURBED AREA SHALL BE SEEDED WITHIN ONE WEEK AFTER OCTOBER 1. A SITE PLAN DEPICTING THE AREAS TO BE SEEDED AND THE AREAS TO REMAIN UNCOVERED SHALL BE SUBMITTED TO THE PUBLIC WORKS CONSTRUCTION INSPECTOR. THE INSPECTOR CAN REQUIRE SEEDING OF ADDITIONAL AREAS IN ORDER TO PROTECT SURFACE WATERS, ADJACENT PROPERTIES, OR DRAINAGE FACILITIES.
- IF A SEDIMENT POND IS NOT PROPOSED, A BAKER TANK OR OTHER TEMPORARY GROUND AND/OR SURFACE WATER STORAGE TANK MAY BE REQUIRED DURING CONSTRUCTION, DEPENDING ON WEATHER CONDITIONS.
- ANY AREA TO BE USED FOR INFILTRATION OR PERVIOUS PAVEMENT (INCLUDING A 5-FOOT BUFFER) MUST BE SURROUNDED BY SILT FENCE PRIOR TO CONSTRUCTION AND UNTIL FINAL STABILIZATION OF THE SITE TO PREVENT SOIL COMPACTION AND SILTATION BY CONSTRUCTION ACTIVITIES.

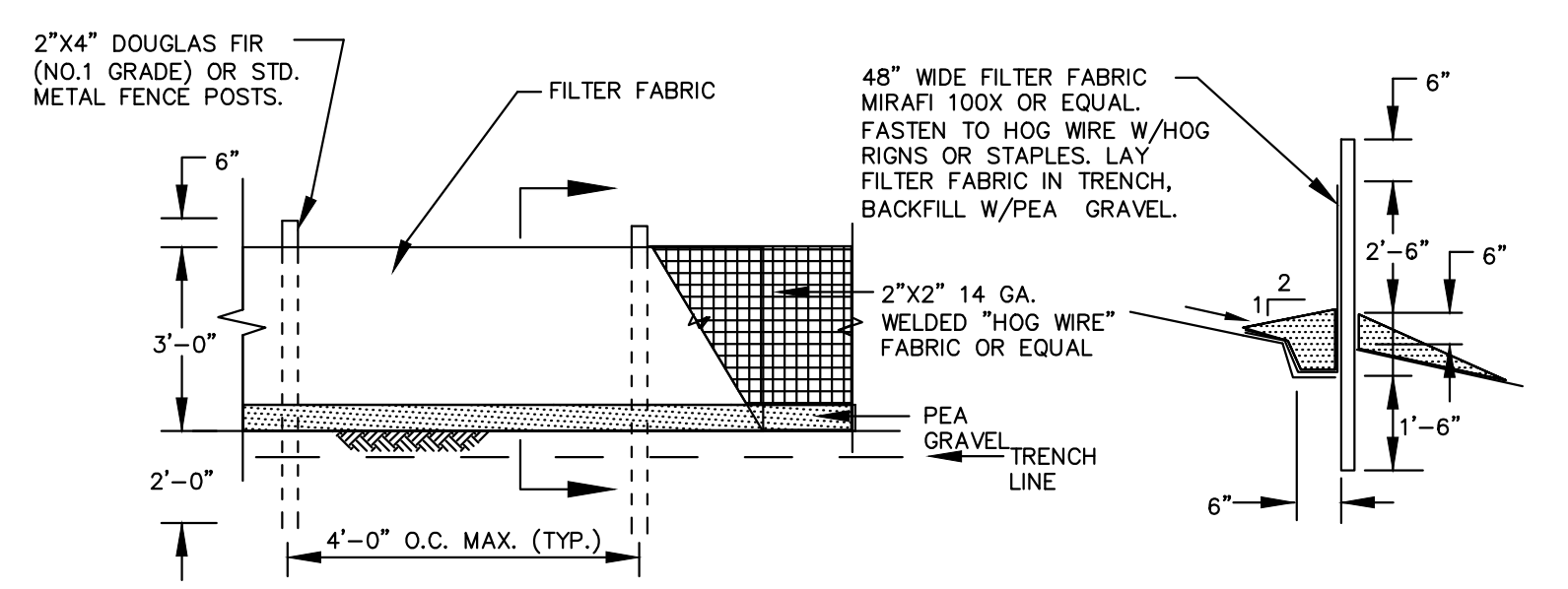

FILTER FABRIC FENCING
N.T.S.

CONSTRUCTION SEQUENCE SCHEDULE

- CONDUCT PRE-CONSTRUCTION MEETING.
- FLAG OR FENCE CLEARING LIMITS.
- POST SIGN WITH NAME AND PHONE NUMBER OF TESC SUPERVISOR.
- INSTALL CATCH BASIN PROTECTION IF REQUIRED.
- GRADE AND INSTALL CONSTRUCTION ENTRANCE(S).
- INSTALL PERIMETER PROTECTION (SILT FENCE, BRUSH BARRIER, ETC.).
- CONSTRUCT SURFACE WATER CONTROLS (INTERCEPTOR DIKES, PIPE SLOPE DRAINS, ETC.) SIMULTANEOUSLY WITH CLEARING AND GRADING FOR PROJECT DEVELOPMENT.
- MAINTAIN EROSION CONTROL MEASURES IN ACCORDANCE WITH CITY OF MERCEUR ISLAND STANDARDS AND MANUFACTURER'S RECOMMENDATIONS.
- RELOCATE EROSION CONTROL MEASURES OR INSTALL NEW MEASURES SO THAT AS SITE CONDITIONS CHANGE, THE EROSION AND SEDIMENT CONTROL IS ALWAYS IN ACCORDANCE WITH THE CITY TESC MINIMUM REQUIREMENTS.
- COVER ALL AREAS WITHIN THE SPECIFIED TIME FRAME WITH STRAW, WOOD FIBER MULCH, COMPOST, PLASTIC SHEETING, CRUSHED ROCK OR EQUIVALENT.
- STABILIZE ALL AREAS THAT REACH FINAL GRADE WITHIN 7 DAYS.
- LEED OR SOO ANY AREAS TO REMAIN UNWORKED FOR MORE THAN 30 DAYS.
- UPON COMPLETION OF THE PROJECT, ALL DISTURBED AREAS MUST BE STABILIZED AND BEST MANAGEMENT PRACTICES REMOVED IF APPROPRIATE.

SWPPP NOTE - MANAGEMENT OF THE PROJECT

IT WILL BE THE RESPONSIBILITY OF THE CONTRACTOR AND DEVELOPER TO MANAGE THIS PROJECT AND COORDINATE WITH THE COUNTY INSPECTOR AND ENGINEER.

THE PERSON MUST HAVE SKILLS TO FIRST ASSESS THE SITE CONDITIONS AND CONSTRUCTION ACTIVITIES THAT COULD IMPACT THE QUALITY OF STORMWATER, AND SECOND ASSESS THE EFFECTIVENESS OF EROSION AND SEDIMENT CONTROL MEASURES USED TO CONTROL THE QUALITY OF STORMWATER DISCHARGES.

WHENEVER INSPECTION AND/OR MONITORING REVEALS THAT THE BMPS IDENTIFIED IN THE CONSTRUCTION SWPPP ARE INADEQUATE, APPROPRIATE BMPS OR DESIGN CHANGES SHALL BE IMPLEMENTED AS SOON AS POSSIBLE.

MAINTAINING AN UPDATED CONSTRUCTION SWPPP: THE CONSTRUCTION SWPPP SHALL BE RETAINED ON-SITE WHENEVER CONSTRUCTION IS UNDERWAY.

ALTHOUGH NOT ANTICIPATED, THE SWPPP SHALL BE MODIFIED WHENEVER THERE IS A CHANGE IN THE DESIGN, CONSTRUCTION, OPERATION, OR MAINTENANCE AT THE CONSTRUCTION SITE THAT HAS, OR COULD HAVE, A SIGNIFICANT EFFECT ON THE DISCHARGE OF POLLUTANTS TO WATERS OF THE STATE.

THE SWPPP SHALL BE MODIFIED IF, DURING INSPECTIONS OR INVESTIGATIONS CONDUCTED BY THE OWNER/OPERATOR, OR THE APPLICABLE LOCAL OR STATE REGULATORY AUTHORITY, IT IS DETERMINED THAT THE SWPPP IS INEFFECTIVE IN ELIMINATING OR SIGNIFICANTLY MINIMIZING POLLUTANTS IN STORMWATER DISCHARGES FROM THE SITE. THE SWPPP SHALL BE MODIFIED AS NECESSARY TO INCLUDE ADDITIONAL OR MODIFIED BMPS DESIGNED TO CORRECT PROBLEMS IDENTIFIED. REVISIONS TO THE SWPPP SHALL BE COMPLETED WITHIN SEVEN DAYS FOLLOWING INSPECTION.

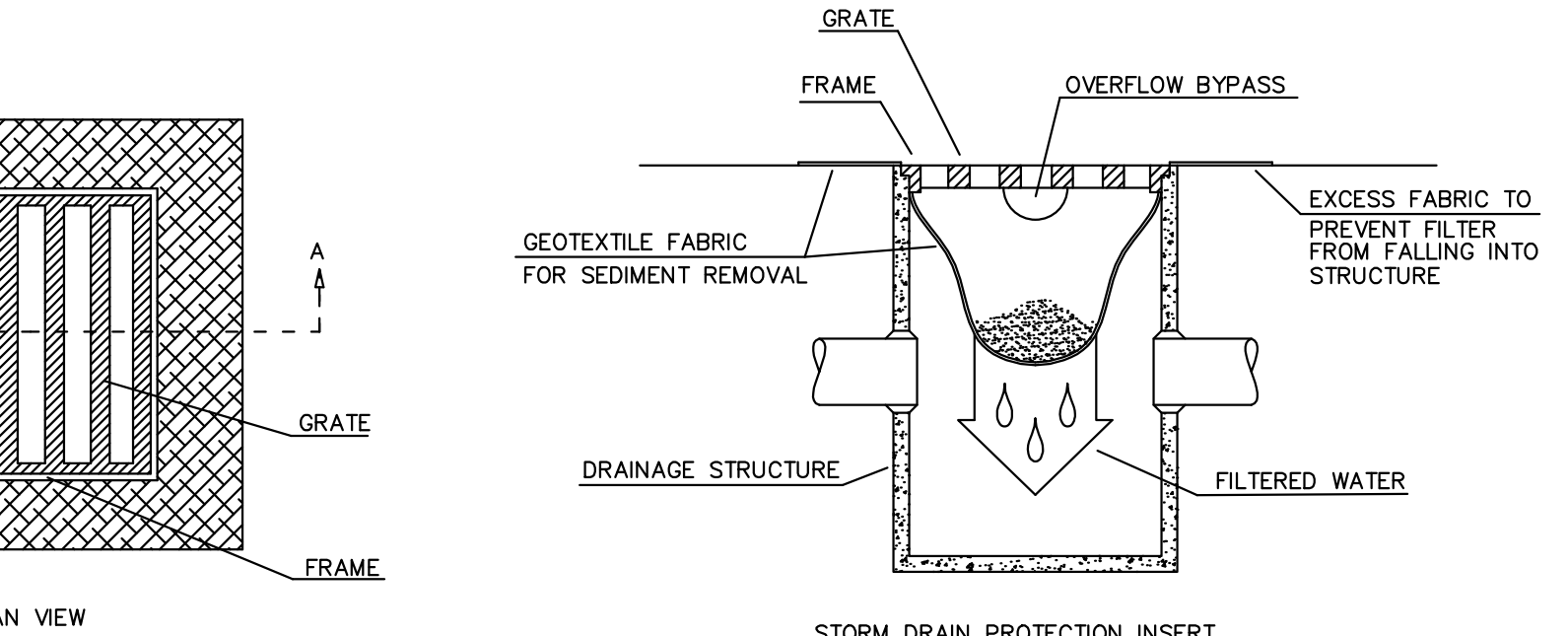

STORM DRAIN PROTECTION INSERT
SECTION A-A
N.T.S.

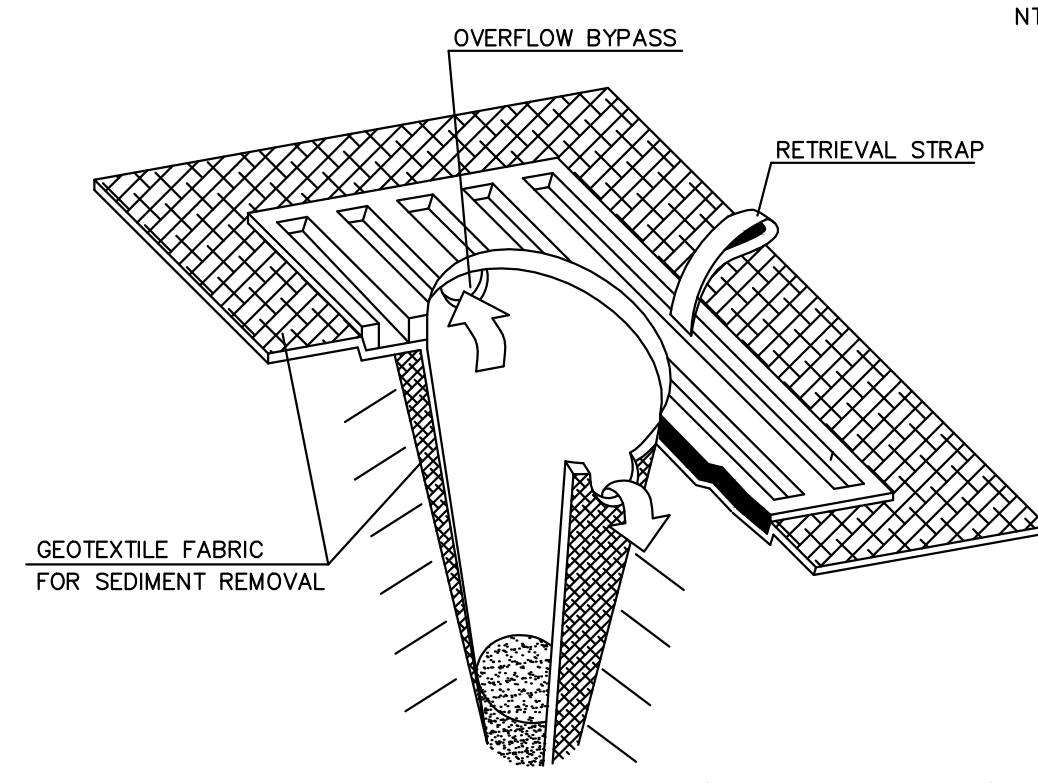

STORM DRAIN PROTECTION INSERT DETAIL
NOT TO SCALE

CALL 3 WORKING DAYS BEFORE YOU DIG
811
UTILITIES UNDERGROUND LOCATION CENTER
(800) 487-0000
UTILITY-RED, TELECOM-ORANGE, GAS-YELLOW, WATER-BLUE, SLOPE-GRAY, CABLE-TV-ORANGE, SLOPE-GRAY, SLOPE-GRAY

APPROVAL _____ DATE _____
CITY OF MERCEUR ISLAND DEVELOPMENT SERVICES GROUP

LITCHFIELD ENGINEERING
12840 81ST AVENUE NE
Kirkland, WA 98034
Tel (425) 821-5038 Fax (425) 821-5739

TESC & SWPPP PLAN
LBH RESIDENCE
7450 NORTH MERCER WAY
SCAN KELL
14033 SE 92ND STREET
NEWCASTLE, WA 98059

Tree #	DBH	Species	Exceptional Tree?	Large Regulated Tree?	Proposed for Removal?	Notes
NATIVE EVERGREENS						
1	19.4"	Western Red Cedar	No	Yes	-	Mulch with wood chips
2	22.8"	Western Red Cedar	No	Yes	-	Mulch with wood chips
3	14.9"	Douglas Fir	No	Yes	-	Decompact soil with air spade, expose root flare (trunk buried)
4	6.2"	Western Red Cedar	No	No	-	Decompact soil with air spade, expose root flare (trunk buried); scars north side of trunk;
5	33.3"	Douglas Fir	Yes	Yes	-	Owner arranging removal of English Ivy; top lost in past.
6	14.2"	Douglas Fir	No	Yes	-	
7	15.2"	Western Red Cedar	No	Yes	YES	
8	11.2"	Common Hawthorn	No	No	-	
DECIDUOUS TREES						
9	Under 10"	Camellia japonica	No	No	-	
10	13.9"	Red Leaf Plum	No	Yes	YES	Ivy in Canopy
RIGHT OF WAY TREES						
11	19.7"	Austrian Black Pine, 3 stems	No	No	-	Ivy in Canopy
12	18.4"	Western Red Cedar	No	Yes	-	*All Cedars in ROW have been topped by utility co; Ivy
13	6"	English Holly	No	No	YES	Invasive
14	23.9"	Western Red Cedar	No	Yes	-	
15	20"	Western Red Cedar	No	Yes	-	
16	6.3"	Western Red Cedar	No	No	-	
17	7.8"	Western Red Cedar	No	No	-	
18	11.9"	Western Red Cedar	No	No	-	
19	8.7"	Western Red Cedar	No	No	-	
20	7.8"	Western Red Cedar	No	No	-	
21	13.3"	Western Red Cedar	No	Yes	-	
22	13.6"	Western Red Cedar	No	No	-	
23	12.6"	Flowering Plum	No	No	YES	
24	7.6"	Vine Maple	No	No	YES	
25	7.1"	Western Red Cedar	No	No	-	

Tree Protection

- All existing trees and shrubs on the property are to remain and be protected throughout construction, unless otherwise noted.
- Tree Protection Fencing:** Install tree protection fencing in locations indicated on plan. Fencing will need periodic adjustment as project work progresses. Proposed tree protection fence relocations to be reviewed in the field with Landscape Architect (LA).
- Restricted Activities in Tree Protection Areas:** Construction trailers, traffic and storage areas shall remain outside the fenced areas at all times. No materials, equipment, spoil, waste or wastewater (i.e., cement, paint) may be stored, deposited, or parked within the tree protection zone (fenced area) at any time. Exemptions may be made by the LA to store materials on existing paved areas under trees.
- Restricted Activity in Root Zone of Trees:** No storage of equipment or materials shall be allowed within the drip-line of trees.
- Temporary access to root zones:** Where construction operations unavoidably require temporary access over tree root zones or other soil protection areas, provide protection as follows: For foot access or similar light surface impacts, apply a 6" layer of arborist wood chips mulch and water regularly to maintain moisture, control erosion and protect roots. For any vehicle or equipment access, apply a minimum one inch steel plate or 4 inch thick timber planking over 2-3 inches of arborist wood chip mulch to protect roots and root zone soil from disturbance or compaction.
- Protection from equipment stabilizers:** Steel planking, or timber planking made of 4-inch thick material, each plank covering a minimum of 8 square feet, shall be used to support backhoe/equipment stabilizers when set within the drip-line of a tree.
- Pruning:** All efforts shall be made to avoid conflicts with tree limbs by temporarily tying up low limbs in the way of the work. When the Contractor anticipates construction operations that will unavoidably affect tree limbs, the Contractor shall notify the LA at least five (5) Working Days in advance of any pruning needed, and shall notify the LA of the proposed method and the amount of pruning required. Pruning shall be done by an ISA certified arborist. Pruning shall not be done by the General Contractor.
- Tree Trunk Protection:** Provide individual tree trunk protection for trees as noted on plan. Tree trunk protection shall consist of 2" x 4" Lumber, 8' long, wired together and spaced approximately 6" on center around individual tree trunks, or a freestanding wood "cage" built around the trunk.
- Trenching and Tunneling Within the Drip-Line:** Excavation within the drip line of trees shall be by hand digging or air spade excavation. Consult LA to review roots in areas to be excavated as the work begins.
- Trenching and Tunneling Outside the Drip Line:** Excavation around roots 2-inches in diameter and greater requires handwork or air spading. All individual tree roots 2-inches or greater in diameter shall be protected whenever encountered. Tree roots smaller than 2-inches in diameter shall be cleanly cut flush with the edge of the trench or tunnel when necessary. Disinfect cutting tools frequently. Ripping or tearing of tree roots will not be allowed.
- Root Hydration:** Exposed roots to be kept hydrated during exposure to air with wet natural burlap laid over the roots, watered at least once daily.

12. Repair, Replacement and Payment for Damage:

- A. Trees or other plants not ordered or designated to be removed but that are destroyed or irreparably damaged by Contractor operations as determined by the Landscape Architect, shall be repaired or replaced in kind and size by the Contractor in accordance with the Landscape Architect's recommendations.
- Replacements shall be of the same species and as nearly as possible of the same size as the trees to be replaced.
 - The Contractor shall allow ten (10) Working Days advance notice for inspection of nursery stock replacements by the Landscape Architect.
- B. **Payment:** In addition to the Contractor's restoration approved by the Landscape Architect, the Contractor will be assessed damages for the difference in the dollar value of the damaged tree, shrub, or other plants, and the dollar value of the replacement.
- The dollar value will be determined by the Engineer from the "Guide for Establishing Values of Trees and Other Plants," prepared by the Council of Tree and Landscape Appraisers, current edition. Damages assessed will be deducted from moneys due or that may become due to the Contractor.
- C. Planting of replacement stock shall be done in accordance with the requirements of the Contract Documents during the first fall or spring planting period, whichever comes first.
- D. Any damage to trees shall be reported to the Landscape Architect immediately so that remedial action can be taken to the affected tree(s). Timeliness of the remedial action can be critical to the tree's health.
12. **Tree and Shrub Removals:** Confirm all trees and shrubs to be removed in field with LA before any removals are completed.
13. **Tree and Shrub Transplanting:** Confirm all trees and shrubs to be transplanted in field with Landscape Architect (LA) before transplanting begins. Transplanting of trees should be scheduled when trees are dormant in late fall and winter (end October - February). Shrubs to be transplanted should ideally be planted in new locations immediately after digging to avoid need for storage, extra care and double handling. If this is not possible, they should be heeled in a protected, shaded area, with adequate irrigation and mulch around the roots to keep them hydrated.

TREE INVENTORY

TREE PROTECTION NOTES

REPLACEMENT TREES - 8 REQUIRED PER City of Mercer Island Tree Inventory and Replacement Submittal Form See Landscape Plan for New Tree Locations;

ROW TREES:

- #22 - 13.6" CEDAR
- #21 - 13.0" CEDAR
- #19, #20 - 7" CEDARS
- #18 - 11.9" CEDAR
- #16, #17 - 8" CEDARS
- #15 - 20" CEDAR
- #14 - 23.9" CEDAR
- #13 - 6" HOLLY - REMOVE
- #12 - 18.4" CEDAR

LEGEND

- X-X-X Tree Protection Fencing
- ⊗ Tree to be Removed
- Area to Receive 4" DEPTH WOOD CHIPS
- Tree to Receive Trunk Protection

TREE INVENTORY, PROTECTION and REMOVAL PLAN

Scale 1/2" = 1'-0"

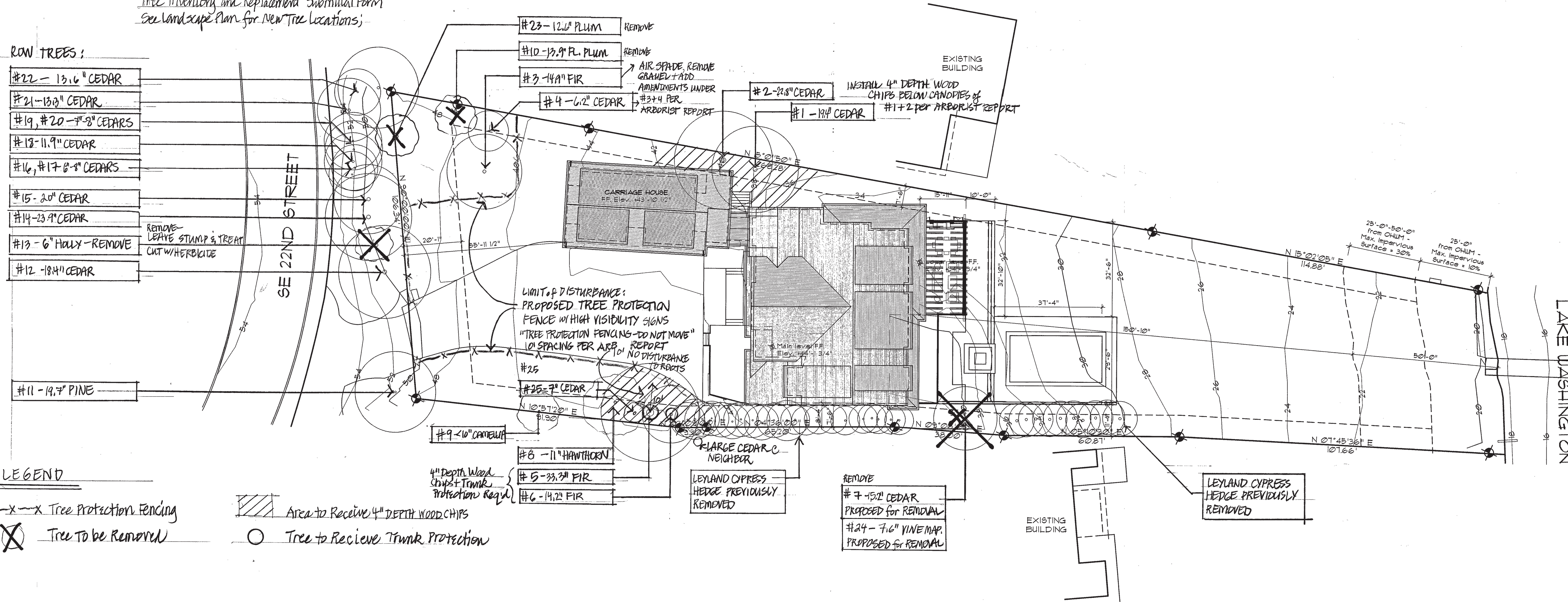

DRAWN BY
DESIGN BY
CHECKED BY
APPROVED BY
DATE
PERMIT
3/1/2019
REVISIONS

ANNE JAMES LANDSCAPE ARCH

24539 NE 11th STREET
REDMOND, WASHINGTON 98074
425 894 9857

LBH RESIDENCE

7450 NORTH MERCER WAY
MERCER ISLAND, WASHINGTON

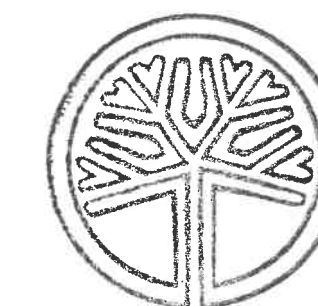

STATE OF WASHINGTON
REGISTERED
LANDSCAPE ARCHITECT
Anne James
ANNE JAMES
CERTIFICATE NO. 864

Tree Inventory, Protection and Removals Plan

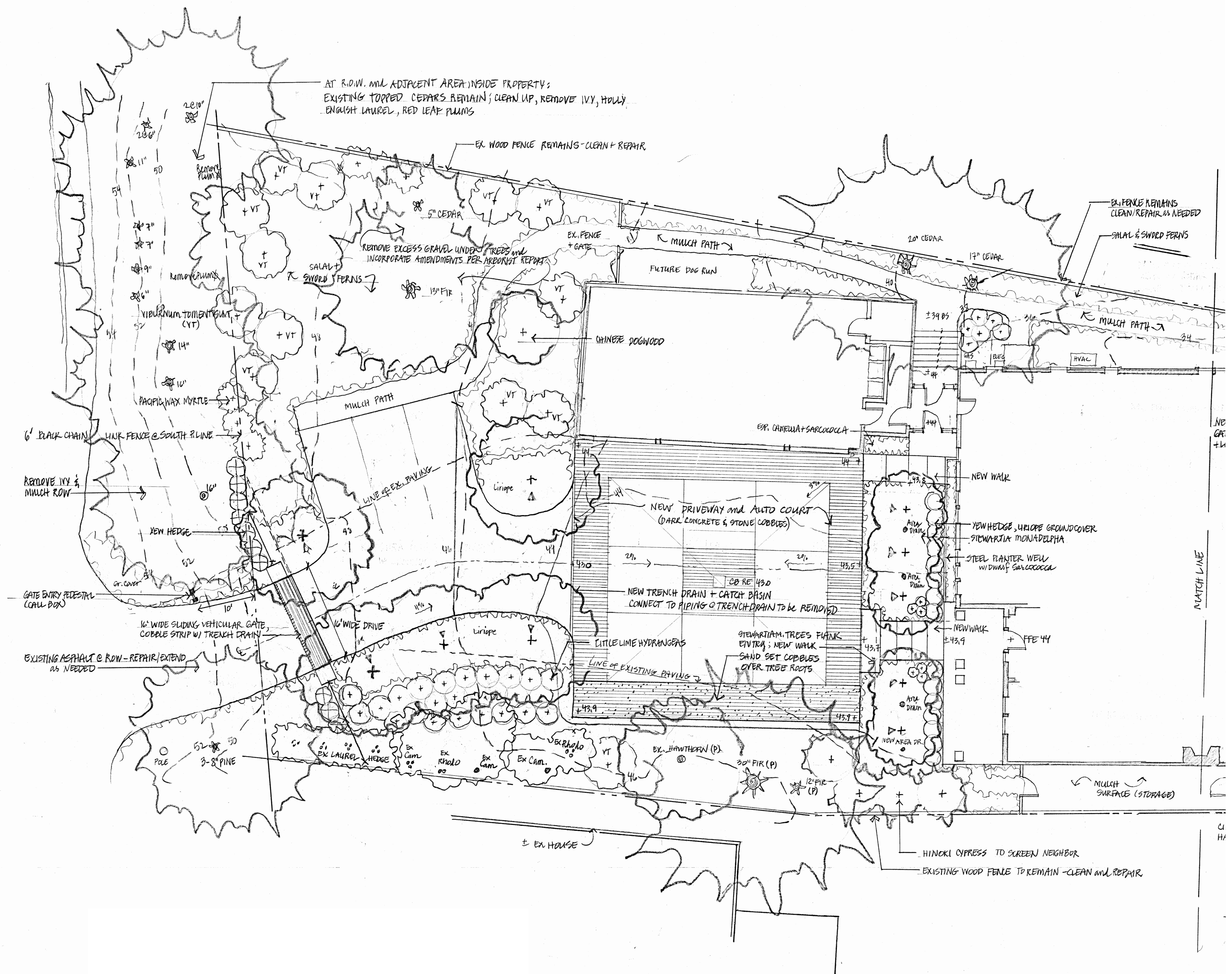

AT R.O.W. AND ADJACENT AREA INSIDE PROPERTY:
 EXISTING TOPPED CEDARS REMAIN; CLEAN UP, REMOVE IVY, HOLLY,
 ENGLISH LAUREL, RED LEAF PLUMS

EX WOOD FENCE REMAINS - CLEAN + REPAIR

EX FENCE REMAINS
 CLEAN/REPAIR AS NEEDED

SALAL & SWORD FERNS

REMOVE EXCESS GRAVEL UNDER TREES AND
 INCORPORATE AMENDMENTS PER ARBORIST REPAIR

EX. FENCE + GATE

MULCH PATH

FUTURE DOG RUN

20" CEDAR

17" CEDAR

MULCH PATH

CHINESE DOGWOOD

MULCH PATH

ESP. CANEHLIA + SARCOCCOLA

NEW WALK

NEW DRIVEWAY AND AUTO COURT
 (DARK CONCRETE & STONE COBBLES)

YEW HEDGE, URLOPE GROUND COVER

STEWARTIA MONADELPHA

STEEL PLANTER WELL
 W/ DRAIN SARCOCCOLA

NEW TRENCH DRAIN + CATCH BASIN
 CONNECT TO PIPING @ TRENCH DRAIN TO BE REMOVED

NEW WALK

FFE 44

LITTLE LIME HYDRANGEAS

STEWARTIA TREES PLANK
 ENTRY; NEW WALK
 SAND SET COBBLES
 OVER TREE ROOTS

LINE OF EXISTING PAVING

NEW WALK

NEW AREA DR.

AREA DRAIN

AREA DRAIN

AREA DRAIN

AREA DRAIN

AREA DRAIN

AREA DRAIN

AREA DRAIN

AREA DRAIN

AREA DRAIN

AREA DRAIN

AREA DRAIN

AREA DRAIN

AREA DRAIN

AREA DRAIN

AREA DRAIN

AREA DRAIN

AREA DRAIN

AREA DRAIN

AREA DRAIN

AREA DRAIN

AREA DRAIN

AREA DRAIN

AREA DRAIN

AREA DRAIN

LEGEND

- EXISTING EVERGREEN TREE
- EXISTING DECIDUOUS TREE
- PROPOSED TREE/SHRUB
- PROPOSED GROUND COVER
FERNS, SMALL SHRUBS
- MITIGATION PLANTING
(DOCK REPAIRS)
- PROPOSED CONTOUR
- EXISTING CONTOUR
- LANDSCAPE UPLIGHT
- LANDSCAPE PATH LIGHT
- IN PAVEMENT MICRO
DRIVE STAR LIGHT
- TOP OF WALL ELEVATION
- BOTTOM OF WALL ELEVATION
- RIM ELEVATION
- CATCH BASIN
- AREA DRAIN
- PROPOSED ELEVATION

Scale 1" = 8'

DRAWN BY
 DESIGN BY
 CHECKED BY
 APPROVED BY
 DATE
 PERMIT
 3/1/2019
 REVISIONS

ANNE JAMES
 LANDSCAPE ARCH

24539 NE 11th STREET
 REDMOND, WASHINGTON 98074
 425 894 9857

LBH
 RESIDENCE

7450 NORTH MERCER WAY
 MERCER ISLAND, WASHINGTON

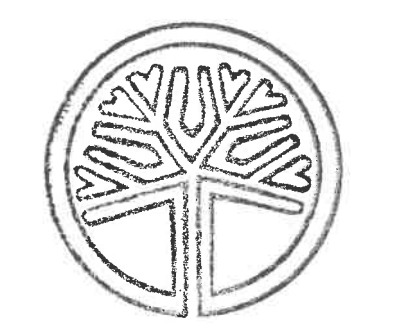

STATE OF WASHINGTON
 REGISTERED
 LANDSCAPE ARCHITECT
 Anne James
 ANNE JAMES
 CERTIFICATE NO. 864

Landscape Plan - South

L-2.0

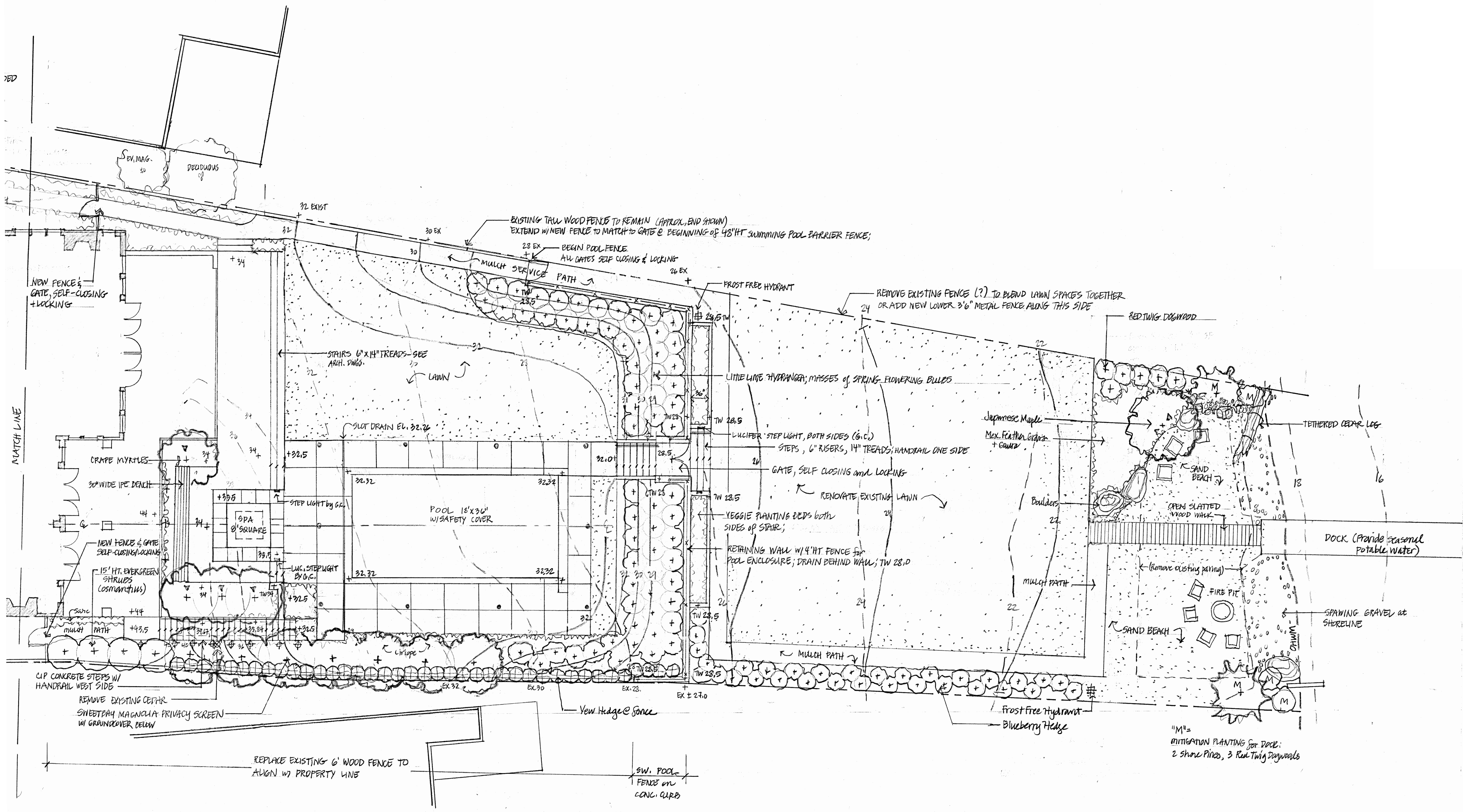

DRAWN BY
 DESIGN BY
 CHECKED BY
 APPROVED BY
 DATE
 PERMIT
 3/1/2019
 REVISIONS

**ANNE JAMES
 LANDSCAPE ARCH**

24539 NE 11th STREET
 REDMOND, WASHINGTON 98074
 425 894 9857

**LBH
 RESIDENCE**

7450 NORTH MERCER WAY
 MERCER ISLAND, WASHINGTON

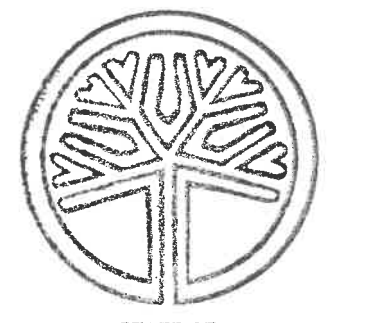

STATE OF WASHINGTON
 REGISTERED
 LANDSCAPE ARCHITECT
Anne James
 ANNE JAMES
 CERTIFICATE NO. 664

Landscape Plan - North

Scale 1" = 8'

L-2.1

LBH RESIDENCE PLANTING SCHEDULE

Quantity	Size	Latin Name	Common Name	Spacing	Notes
TREES					
1	10'12' ht	Acer specimen TBD	Japanese Maple Specimen		Shoreline shade tree
5	4" caliper	Cercidiphyllum japonicum	Katsura		Matched Specimens for driveway
5	12' ht	Chamaecyparis obtuse "Gracilis"	Slender Hinoki Cypress		Screening east of entry
1	3" caliper	Cornus kousa	Chinese dogwood		South of garage
7	16'-18' ht., multistemmed or low branched	Magnolia virginiana Jim Wilson "Moonglow"	Moonglow Sweetbay Magnolia		Screening east of pool
5	4" caliper	Stewartia monadelphica	Red bark Stewartia		Specimens at front entry bed
4	10'-12' ht. multi-stemmed clumps	Lagerstroemia variety TBD, possible Osage (light pink)	Crape Myrtle		Around spa; low growing variety to 20' max.;
SHRUBS					
1	15 gallon, espaliered	Camellia s. 'Setsugekka'	Espaliered Setsugekka Camellia		Against garage near entry link
6	5 gallon	Cornus sericea "Bayleyi"	Red Twig Dogwood		3 as mitigation planting at shoreline, rest nearby
6	30"36" ht and spread	Daphne transatlantica "Blafra" Eternal Fragrance	Hybrid Daphne		Front entry
200	2 gallon	Gaultheria shallon	Salal	24"	Place in field; groundcover west side of house, south of garage
84	5 gallon	Hydrangea "Little Lime"	Little lime hydrangea		64 north of pool, 20 along driveway
15	5 gallon	Myrica californica	Pacific Wax Myrtle		South property line – see plan
5	8'-10' ht, loose form	Osmanthus burkwoodii	Sweet Olive		Screening east property line at upper terrace
10	5 gallon	Ribes sanguinum	Red Flowering Currant	48"	
140	2 gallon	Sarcococca humilis hookeriana	Dwarf Sweet Box	18"	Place in field
7	5 gallon	Syringa "Angel White"	Lilac		West side of terrace
40 LF	4' ht.	Taxus x. media "Hicksii"	Hicks Yew		Entry area
110 LF	6' Ht.	Taxus x. media "Hicksii"	Hicks Yew		East and west of gate columns 20 LF; 90 LF East PL east of pool
36	5 gallon	Vaccinium varieties TBD	Blueberries	36"	
12	4'-5' ht	Viburnum tomentosum "Mariesii"	Doublefile viburnum		
GROUND COVERS, VINES and PERENNIALS					
100	1 gallon	Perennials TBD			Daylilies, perennial geraniums, peonies, iris, Japanese anemone
40	1 gallon	Gaura lindheimeri "Whirling Butterflies"	White Wand Flower		
12	1 gallon	Helleborus "Jacob"	Jacob Hellebore	18"-24"	Place in field
12	1 gallon	Hellebore Winter Jewel "Onyx Odyssey"	Onyx Odyssey Hellebore		Place in field
3	5 gallon	Hydrangea petiolaris	Climbing hydrangea vine		North facing stucco wall south of spa
1500	4" pots	Liriope spicata	Mondo Grass	12"	
120	1 gallon	Nasella tenuissima	Mexican Feather Grass		
400	1 gallon	Polystichum munitum	Sword Fern	24"	
50	5 gallon	Trachelospermum jasminoides	Star Jasmine, Bush form	24"	Groundcover under Crape Myrtles at spa
18	1 gallon	Trillium grandiflorum	Great White Trillium		Place in field

MITIGATION PLANTING FOR DOCK WORK

2	8'-10' ht.	Pinus contorta	Shore Pine		Dock mitigation planting at shoreline – to be planted within 10' of shoreline
3	5 gallon	Cornus sericea	Red Twig Dogwood		Dock mitigation planting at shoreline – to be planted within 10' of shoreline

Planting Notes

- Landscape contractor shall verify location of all site utilities with general contractor prior to landscape implementation.
- Prior to commencing with any work, landscape contractor to set up a pre-installation meeting to discuss installation procedures and coordination issues. At a minimum, attendees to include landscape architect, landscape contractor, and general contractor.
- All plant material to be healthy and free of disease. Plant stock must conform to American Nurseryman standards and general horticultural practices. All trees shall be specimen quality. All plants shall be nursery grown and shall be of type, size, and condition specified. The plants shall exhibit normal habits of growth for their species. They shall have buds intact and shall be free of disease, insects, scars, bruises, breaks, etc.
- All plants shall be selected and approved by the landscape architect prior to planting, through a combination of nursery visits and review of plant samples and photographs.
- Coordinate plant locations with existing / proposed utilities, fencing, sprinkler systems, and other site appurtenances to avoid conflicts.
- General contractor to verify that subgrade is properly prepared before landscape contractor begins with finish grading and importation of topsoil. This includes removing all construction debris to full depth. The general contractor should verify that the subgrade in planting areas has not been compacted by construction activity. If subgrade is compacted, it should be loosened by the general contractor to 90% compaction within the top 18".
- Landscape contractor to scarify the subgrade of all new planting areas to a depth of ±6" before placing topsoil using a rototiller or other appropriate equipment to achieve the specified depths. In areas where scarifying may damage existing tree roots, review conditions in the field with the landscape architect. After scarifying, remove all sticks, stones, etc., larger than ½" in any dimension. Mix topsoil or compost (depending on location) into subgrade layer a minimum of 3" by rototilling or other means.
- Planting soil and amendments:
 - New planting soil: topsoil to depths as follow:
 - Lawn areas 70/30 mix - 12" deep
 - Shrub Beds – Planting Soil, 60/40 or 50/50, 24" deep, if conditions allow; review with LA.
 - Tree planting beds – Planting soil 36" deep, if conditions allow; review with LA.
 - Renovated planting beds with new plantings: Amend with 3" depth compost and ground kelp at 1lb per SF, dug or tilled in to a depth of 3", except in areas of tree roots, where it should be incorporated in gently by hand.
 - All planting beds to receive 2" depth of fine bark mulch.
- Inoculate new plantings and existing trees with microbial tea after installation but before mulching.
- Container plants shall be well established but not root bound. If roots encircle themselves in the pots, the roots shall be loosened and/or sliced through to encourage natural outward growth.
- Contractor shall provide and plant the numbers of plants listed or shown on the plans— whichever is greater.
- No plant substitutions (size or variety) or omissions unless approved in writing by landscape architect.
- All shrubs and trees to be laid out for approval or final planting location by landscape architect before planting.
- Plant groundcover on triangular spacing. Plant shrubs as shown on plans or as directed by landscape architect.

DRAWN BY

DESIGN BY

CHECKED BY

APPROVED BY

DATE

PERMIT
3/1/2019

REVISIONS

**ANNE JAMES
LANDSCAPE ARCH**

24539 NE 11th STREET
REDMOND, WASHINGTON 98074
425 894 9857

**LBH
RESIDENCE**

7450 NORTH MERCER WAY
MERCER ISLAND, WASHINGTON



CERTIFICATE NO. 864

Planting Schedule
and Planting Notes

L-2.2

General Structural Notes

THE FOLLOWING APPLY UNLESS SHOWN OTHERWISE ON THE DRAWINGS

CRITERIA

- ALL MATERIALS, WORKMANSHIP, DESIGN, AND CONSTRUCTION SHALL CONFORM TO THE DRAWINGS, SPECIFICATIONS, AND THE INTERNATIONAL BUILDING CODE (2015 EDITION).
- ALL MATERIALS, WORKMANSHIP, DESIGN, AND CONSTRUCTION SHALL CONFORM TO THE DRAWINGS, SPECIFICATIONS, THE INTERNATIONAL BUILDING CODE (2015 EDITION). THIS STRUCTURE DOES NOT CONFORM TO PRESENT EARTHQUAKE CODE REQUIREMENTS. IT HAS BEEN ANALYZED AND REINFORCED FOR MINIMUM MAINTENANCE IN ACCORDANCE WITH INTERNATIONAL EXISTING BUILDING CODE, AND IS WITHIN THE CURRENT PRACTICE FOR THE RENOVATION OF EXISTING BUILDINGS OF THIS AGE AND TYPE OF CONSTRUCTION.
- DESIGN LOADING CRITERIA:
RESIDENTIAL – ONE AND TWO-FAMILY DWELLINGS
FLOOR LIVE LOAD 40 PSF
DECKS 1.5 x AREA SERVED
DEFLECTION CRITERIA
LIVE LOAD DEFLECTION L/360
TOTAL LOAD DEFLECTION L/240
ENVIRONMENTAL LOADS
SNOW Ce=1.0, Is=1.0, Ct=1.1, Pg=25 PSF, Pf=20 PSF
WIND Gcpi=0.18, 110 MPH, RISK CATEGORY II, EXPOSURE "B"
EARTHQUAKE . ANALYSIS PROCEDURE: EQUIVALENT LATERAL FORCE PROCEDURE
LATERAL SYSTEM: LIGHT FRAMED SHEAR WALLS,
SITE CLASS=D, Ss=136, Sds=91, S1=53, SD1=53, Cs=0.140
SDC D, Ie=1.0, R=6.5
- STRUCTURAL DRAWINGS SHALL BE USED IN CONJUNCTION WITH ARCHITECTURAL DRAWINGS FOR BIDDING AND CONSTRUCTION. ARCHITECTURAL DRAWINGS ARE THE PRIME CONTRACT DRAWINGS. ANY DISCREPANCIES FOUND AMONG THE DRAWINGS, THE SPECIFICATION, THESE GENERAL NOTES AND THE SITE CONDITIONS SHALL BE REPORTED TO THE ARCHITECT, WHO SHALL CORRECT SUCH DISCREPANCY IN WRITING. ANY WORK DONE BY THE GENERAL CONTRACTOR AFTER DISCOVERY OF SUCH DISCREPANCY SHALL BE DONE AT THE GENERAL CONTRACTOR'S RISK.
- PRIMARY STRUCTURAL ELEMENTS NOT DIMENSIONED ON THE STRUCTURAL PLANS AND DETAILS SHALL BE LOCATED BY THE ARCHITECTURAL PLANS AND DETAILS. VERTICAL DIMENSION CONTROL IS DEFINED BY THE ARCHITECTURAL WALL SECTIONS, BUILDING SECTION, AND PLANS. DETAILING AND SHOP DRAWING PRODUCTION FOR STRUCTURAL ELEMENTS WILL REQUIRE DIMENSIONAL INFORMATION CONTAINED IN BOTH ARCHITECTURAL AND STRUCTURAL DRAWINGS.
- CONTRACTOR SHALL BE RESPONSIBLE FOR ALL SAFETY PRECAUTIONS AND THE METHODS, TECHNIQUES, SEQUENCES OR PROCEDURES REQUIRED TO PERFORM THE CONTRACTORS WORK. THE STRUCTURAL ENGINEER HAS NO OVERALL SUPERVISORY AUTHORITY OR ACTUAL AND/OR DIRECT RESPONSIBILITY FOR THE SPECIFIC WORKING CONDITIONS AT THE SITE AND/OR FOR ANY HAZARDS RESULTING FROM THE ACTIONS OF ANY TRADE CONTRACTOR. THE STRUCTURAL ENGINEER HAS NO DUTY TO INSPECT, SUPERVISE, NOTE, CORRECT, OR REPORT ANY HEALTH OR SAFETY DEFICIENCIES TO THE OWNER, CONTRACTORS, OR OTHER ENTITIES OR PERSONS AT THE PROJECT SITE.
- CONTRACTOR SHALL PROVIDE TEMPORARY BRACING FOR THE STRUCTURE AND STRUCTURAL COMPONENTS UNTIL ALL FINAL CONNECTIONS HAVE BEEN COMPLETED IN ACCORDANCE WITH THE PLANS. CONFORM TO ASCE 37-14 "DESIGN LOADS ON STRUCTURES DURING CONSTRUCTION".
- CONTRACTOR-INITIATED CHANGES SHALL BE SUBMITTED IN WRITING TO THE ARCHITECT AND STRUCTURAL ENGINEER FOR APPROVAL PRIOR TO FABRICATION OR CONSTRUCTION. CHANGES SHOWN ON SHOP DRAWINGS ONLY WILL NOT SATISFY THIS REQUIREMENT.
- DRAWINGS INDICATE GENERAL AND TYPICAL DETAILS OF CONSTRUCTION. WHERE CONDITIONS ARE NOT SPECIFICALLY INDICATED BUT ARE OF SIMILAR CHARACTER TO DETAILS SHOWN, SIMILAR DETAILS OF CONSTRUCTION SHALL BE USED, SUBJECT TO REVIEW AND APPROVAL BY THE ARCHITECT AND THE STRUCTURAL ENGINEER. ALL TYPICAL NOTES AND DETAILS SHOWN ON DRAWINGS SHALL APPLY, UNLESS NOTED OTHERWISE. TYPICAL DETAILS MAY NOT NECESSARILY BE INDICATED ON THE PLANS BUT SHALL STILL APPLY AS SHOWN OR DESCRIBED IN THE DETAILS. WHERE TYPICAL DETAILS ARE NOTED ON THE PLANS, THE SPECIFIED TYPICAL DETAIL SHALL BE USED. WHERE NO TYPICAL DETAIL IS NOTED, IT SHALL BE THE CONTRACTOR'S RESPONSIBILITY TO CHOOSE THE APPROPRIATE TYPICAL DETAIL FROM THOSE PROVIDED OR REQUEST ADDITIONAL INFORMATION. THE CONTRACTOR SHALL SUBMIT ALL PROPOSED ALTERNATE TYPICAL DETAILS TO THOSE PROVIDED WITH RELATED CALCULATIONS TO THE ENGINEER FOR APPROVAL PRIOR TO SHOP DRAWING PRODUCTION AND FIELD USE.
- ALL STRUCTURAL SYSTEMS, WHICH ARE TO BE COMPOSED OF COMPONENTS TO BE FIELD ERRECTED, SHALL BE SUPERVISED BY THE SUPPLIER DURING MANUFACTURING, DELIVERY, HANDLING, STORAGE AND ERECTION IN ACCORDANCE WITH INSTRUCTIONS PREPARED BY THE SUPPLIER.

GEOTECHNICAL

- FOUNDATION NOTES: ALLOWABLE SOIL PRESSURE AND LATERAL EARTH PRESSURE ARE ASSUMED AND THEREFORE MUST BE VERIFIED BY A QUALIFIED SOILS ENGINEER OR APPROVED BY THE BUILDING OFFICIAL. IF SOILS ARE FOUND TO BE OTHER THAN ASSUMED, NOTIFY THE STRUCTURAL ENGINEER FOR POSSIBLE FOUNDATION REDESIGN.

FOOTINGS SHALL BEAR ON FIRM, UNDISTURBED EARTH AT LEAST 18" BELOW ADJACENT FINISHED GRADE. UNLESS OTHERWISE NOTED, FOOTINGS SHALL BE CENTERED BELOW COLUMNS OR WALLS ABOVE.

BACKFILL BEHIND ALL RETAINING WALLS WITH FREE DRAINING, GRANULAR FILL AND PROVIDE FOR SUBSURFACE DRAINAGE.

ALLOWABLE SOIL PRESSURE. 2000 PSF
LATERAL EARTH PRESSURE (RESTRAINED/UNRESTRAINED) 55 PCF/35 PCF
ALLOWABLE PASSIVE EARTH PRESSURE (FS OF 1.5 INCLUDED). 300 PCF
COEFFICIENT OF FRICTION (FS OF 1.5 INCLUDED). 0.3
TRAFFIC SURCHARGE PRESSURE (UNIFORM LOAD) 75 PSF
SEISMIC SURCHARGE PRESSURE (UNIFORM LOAD) 7H PSF

RENOVATION

- DEMOLITION: CONTRACTOR SHALL VERIFY ALL EXISTING CONDITIONS BEFORE COMMENCING ANY DEMOLITION. SHORING SHALL BE INSTALLED TO SUPPORT EXISTING CONSTRUCTION AS REQUIRED AND IN A MANNER SUITABLE TO THE WORK SEQUENCES. DEMOLITION DEBRIS SHALL NOT BE ALLOWED TO DAMAGE OR OVERLOAD THE EXISTING STRUCTURE. LIMIT CONSTRUCTION LOADING (INCLUDING DEMOLITION DEBRIS) ON EXISTING FLOOR SYSTEMS TO 40 PSF.
- CONTRACTOR SHALL VERIFY ALL EXISTING DIMENSIONS, MEMBER SIZES, AND CONDITIONS PRIOR TO COMMENCING ANY WORK. ALL DIMENSIONS OF EXISTING CONSTRUCTION SHOWN ON THE DRAWINGS ARE INTENDED AS GUIDELINES ONLY AND MUST BE VERIFIED. THE CONTRACTOR SHALL NOTIFY THE ARCHITECT AND STRUCTURAL ENGINEER IF EXISTING CONDITIONS DETERMINED DURING WORK VARY FROM THE EXISTING CONSTRUCTION SHOWN ON THE DRAWINGS.
- CONTRACTOR SHALL CHECK FOR DRY ROT AT ALL AREAS OF NEW WORK. ALL ROT SHALL BE REMOVED AND DAMAGED MEMBERS SHALL BE REPLACED OR REPAIRED AS DIRECTED BY THE STRUCTURAL ENGINEER OR ARCHITECT.

CONCRETE

- CONCRETE SHALL BE MIXED, PROPORTIONED, CONVEYED AND PLACED IN ACCORDANCE WITH ACI 301, INCLUDING TESTING PROCEDURES. CONCRETE SHALL ATTAIN A 28-DAY STRENGTH OF $f'c = 3,000$ PSI AND MIX SHALL CONTAIN NOT LESS THAN 5-1/2 SACKS OF CEMENT PER CUBIC YARD AND SHALL BE PROPORTIONED TO PRODUCE A SLUMP OF 5" OR LESS. REQUIRED CONCRETE STRENGTH IS BASED ON THE DURABILITY REQUIREMENTS OF SECTION 1904 OF THE IBC. DESIGN STRENGTH IS $f'c = 2,500$ PSI.
- ALL CONCRETE WITH SURFACES EXPOSED TO WEATHER OR STANDING WATER SHALL BE AIR-ENTRAINED WITH AN AIR-ENTRAINING AGENT CONFORMING TO ASTM C260, C494, AND C618. TOTAL AIR CONTENT FOR FROST-RESISTANT CONCRETE SHALL BE IN ACCORDANCE WITH ACI 318, TABLE 19.3.2.1 MODERATE EXPOSURE, F1.
- DETAILING OF REINFORCING STEEL (INCLUDING HOOKS AND BENDS) SHALL BE IN ACCORDANCE WITH ACI 315-99 AND 318-11. LAP ALL CONTINUOUS REINFORCEMENT #5 AND SMALLER 40 BAR DIAMETERS OR 2'-0" MINIMUM. PROVIDE CORNER BARS AT ALL WALL AND FOOTING INTERSECTIONS. LAP CORNER BARS #5 AND SMALLER 40 BAR DIAMETERS OR 2'-0" MINIMUM. LAPS OF LARGER BARS SHALL BE MADE IN ACCORDANCE WITH ACI 318-11, CLASS B. LAP ADJACENT MATS OF WELDED WIRE FABRIC A MINIMUM OF 8" AT SIDES AND ENDS.

NO BARS PARTIALLY EMBEDDED IN HARDENED CONCRETE SHALL BE FIELD BENT UNLESS SPECIFICALLY SO DETAILED OR APPROVED BY THE STRUCTURAL ENGINEER.

- CONCRETE PROTECTION (COVER) FOR REINFORCING STEEL SHALL BE AS FOLLOWS:

FOOTINGS AND OTHER UNFORMED SURFACES CAST AGAINST AND PERMANENTLY EXPOSED TO EARTH 3"
FORMED SURFACES EXPOSED TO EARTH OR WEATHER (#6 BARS OR LARGER) 2"
FORMED SURFACES EXPOSED TO EARTH OR WEATHER (#5 BARS OR SMALLER) 1-1/2"
COLUMN TIES OR SPIRALS AND BEAM STIRRUPS 1-1/2"
SLABS AND WALLS (INT. FACE). GREATER OF BAR DIAMETER PLUS 1/8" OR 3/4"

- CONCRETE WALL REINFORCING--PROVIDE THE FOLLOWING UNLESS DETAILED OTHERWISE:

6" WALLS	#4 @ 16 HORIZ.	#4 @ 18 VERTICAL	1 CURTAIN
8" WALLS	#4 @ 12 HORIZ.	#4 @ 18 VERTICAL	1 CURTAIN

- CAST-IN-PLACE CONCRETE: SEE ARCHITECTURAL DRAWINGS FOR EXACT LOCATIONS AND DIMENSIONS OF DOOR AND WINDOW OPENINGS IN ALL CONCRETE WALLS. SEE MECHANICAL DRAWINGS FOR SIZE AND LOCATION OF MISCELLANEOUS MECHANICAL OPENINGS THROUGH CONCRETE WALLS. SEE ARCHITECTURAL DRAWINGS FOR ALL GROOVES, NOTCHES, CHAMFERS, FEATURE STRIPS, COLOR, TEXTURE, AND OTHER FINISH DETAILS AT ALL EXPOSED CONCRETE SURFACES, BOTH CAST-IN-PLACE AND PRECAST.

- NON-SHRINK GROUT SHALL BE FURNISHED BY AN APPROVED MANUFACTURER AND SHALL BE MIXED AND PLACED IN STRICT ACCORDANCE WITH THE MANUFACTURER'S PUBLISHED RECOMMENDATIONS. GROUT STRENGTH SHALL BE AT LEAST EQUAL TO THE MATERIAL ON WHICH IT IS PLACED (3000 PSI MINIMUM).

ANCHORAGE

- EXPANSION BOLTS INTO CONCRETE SHALL BE "STRONG-BOLT 2" WEDGE ANCHORS AS MANUFACTURED BY THE SIMPSON STRONG TIE COMPANY AND INSTALLED IN STRICT CONFORMANCE TO ICC-ES REPORT NUMBER ESR-3037, INCLUDING MINIMUM EMBEDMENT REQUIREMENTS. BOLTS INTO CONCRETE MASONRY OR BRICK MASONRY UNITS SHALL BE INTO FULLY GROUTED CELLS. PERIODIC SPECIAL INSPECTION IS REQUIRED TO VERIFY ANCHOR TYPE, ANCHOR DIMENSIONS, ANCHOR LOCATION, TIGHTENING TORQUE, HOLE DIMENSIONS, ANCHOR EMBEDMENT, AND ADHERENCE TO THE INSTALLATION INSTRUCTIONS.
- EPOXY-GROUTED ITEMS (THREADED RODS OR REINFORCING BAR) SPECIFIED ON THE DRAWINGS SHALL BE INSTALLED USING "SET-XP" HIGH STRENGTH EPOXY AS MANUFACTURED BY THE SIMPSON STRONG, TIE COMPANY. INSTALL IN STRICT ACCORDANCE WITH ICC-ES REPORT NO. ESR-2508. MINIMUM BASE MATERIAL TEMPERATURE IS 50 DEGREES, F. RODS SHALL BE ASTM A-36 UNLESS OTHERWISE NOTED. PERIODIC SPECIAL INSPECTION OF INSTALLATION IS REQUIRED TO VERIFY ANCHOR OR EMBEDDED BAR TYPE AND DIMENSIONS, LOCATION, ADHESIVE IDENTIFICATION AND EXPIRATION, HOLE DIMENSIONS, HOLE CLEANING PROCEDURE, ANCHOR EMBEDMENT, AND ADHERENCE TO THE INSTALLATION INSTRUCTIONS. CONTINUOUS SPECIAL INSPECTION IS REQUIRED FOR HORIZONTAL AND OVERHEAD INSTALLATIONS.
- CONCRETE SCREW ANCHORS INTO CONCRETE AND CONCRETE MASONRY UNITS SHALL BE "TITEN HD" HEAVY DUTY SCREW ANCHOR AS MANUFACTURED BY THE SIMPSON STRONG-TIE COMPANY, INSTALLED IN STRICT ACCORDANCE WITH ICC-ES REPORT NO. ESR-2713 (CONCRETE), NO. ESR-1056 (CMU), INCLUDING MINIMUM EMBEDMENT REQUIREMENTS. SCREW ANCHORS INTO CONCRETE MASONRY UNITS SHALL BE INTO FULLY GROUTED CELLS. SPECIAL INSPECTION IS REQUIRED.

STEEL

- STRUCTURAL STEEL DESIGN, FABRICATION, AND ERECTION SHALL BE BASED ON:
A. AISC 360 AND SECTION 2205.2 OF THE INTERNATIONAL BUILDING CODE.
B. APRIL 14, 2010 AISC CODE OF STANDARD PRACTICE FOR STEEL BUILDINGS AND BRIDGES AMENDED AS FOLLOWS: AS NOTED IN THE CONTRACT DOCUMENTS, BY THE DELETION OF PARAGRAPH 4.4.1, AND REVISE REFERENCE FROM "STRUCTURAL DESIGN DRAWINGS" TO "CONTRACT DOCUMENTS" IN PARAGRAPH 3.1.
C. SPECIFICATION FOR STRUCTURAL JOINTS USING ASTM A325 OR A490 BOLTS.

- WIDE FLANGE SHAPES SHALL CONFORM TO ASTM A992, Fy = 50 KSI. OTHER ROLLED SHAPES INCLUDING PLATES, SHALL CONFORM TO ASTM A36, Fy = 36 KSI. STEEL PIPE SHALL CONFORM TO ASTM A-53, TYPE E OR S, GRADE B, Fy = 35 KSI. STRUCTURAL TUBING SHALL CONFORM TO ASTM A500, GRADE B, Fy = 42 KSI (ROUND), Fy = 46 KSI (SQUARE AND RECTANGULAR). CONNECTION BOLTS SHALL CONFORM TO ASTM A307.

- ALL STEEL EXPOSED TO THE WEATHER OR IN CONTACT WITH GROUND SHALL BE CORROSION PROTECTED BY GALVANIZATION OR PROVIDED WITH EXTERIOR PAINT SYSTEM, UNLESS OTHERWISE NOTED.

- SHOP PRIME ALL STEEL EXCEPT:

- STEEL ENCASED IN CONCRETE.
- SURFACES TO BE WELDED.
- CONTACT SURFACES AT HIGH-STRENGTH BOLTS.
- MEMBERS TO BE GALVANIZED.
- MEMBERS WHICH WILL BE CONCEALED BY INTERIOR FINISHES.
- SURFACES TO RECEIVE SPRAYED FIREPROOFING.
- SURFACES TO RECEIVE OTHER SPECIAL SHOP PRIMERS.

- ALL ANCHORS EMBEDDED IN MASONRY OR CONCRETE SHALL BE A307 HEADED BOLTS OR A36 THREADED ROD WITH AN ASTM 563 HEAVY HEX NUT TACK WELDED ON THE EMBEDDED END.

- ALL WELDING SHALL BE IN CONFORMANCE WITH AISC AND AWS STANDARDS AND SHALL BE PERFORMED BY WABO CERTIFIED WELDERS USING E70XX ELECTRODES. ONLY PREQUALIFIED WELDS (AS DEFINED BY AWS) SHALL BE USED. ALL COMPLETE JOINT PENETRATION GROOVE WELDS SHALL BE MADE WITH A FILLER MATERIAL THAT HAS A MINIMUM CVN TOUGHNESS OF 20 FT-LBS AT -20 DEGREES F AND 40 FT - LBS AT 70 DEGREES F, AS DETERMINED BY AWS CLASSIFICATION OR MANUFACTURER CERTIFICATION.

WOOD

- FRAMING LUMBER SHALL BE S-DRY, KD, OR MC-19, AND GRADED AND MARKED IN CONFORMANCE WITH WOLB STANDARD "GRADING RULES FOR WEST COAST LUMBER NO. 17", OR WMPA STANDARD, "WESTERN LUMBER GRADING RULES 2011". FURNISH TO THE FOLLOWING MINIMUM STANDARDS:

JOISTS AND BEAMS	(2X & 3X MEMBERS)	HEM-FIR NO. 2 MINIMUM BASE VALUE, Fb = 850 PSI
	(4X MEMBERS)	DOUGLAS FIR-LARCH NO. 1 MINIMUM BASE VALUE, Fb = 1000 PSI
BEAMS	(INCL. 6X AND LARGER)	DOUGLAS FIR-LARCH NO. 1 MINIMUM BASE VALUE, Fb = 1350 PSI
POSTS	(4X MEMBERS)	DOUGLAS FIR-LARCH NO. 2 MINIMUM BASE VALUE, Fc = 1350 PSI
	(6X AND LARGER)	DOUGLAS FIR-LARCH NO. 1 MINIMUM BASE VALUE, Fc = 1000 PSI

STUDS, PLATES & MISC. FRAMING: DOUGLAS-FIR-LARCH OR HEM-FIR NO. 2

- GLUED LAMINATED MEMBERS SHALL BE FABRICATED IN CONFORMANCE WITH ASTM AND ANSI/AITC STANDARDS. EACH MEMBER SHALL BEAR AN AITC OR APA-EWS IDENTIFICATION MARK AND SHALL BE ACCOMPANIED BY AN AITC OR APA-EWS CERTIFICATE OF PERFORMANCE. ALL SIMPLE SPAN BEAMS SHALL BE DOUGLAS FIR COMBINATION 24F-V4, Fb = 2,400 PSI, Fv = 265 PSI. ALL CANTILEVERED BEAMS SHALL BE DOUGLAS FIR COMBINATION 24F-V8, Fb = 2400 PSI, Fv = 265 PSI.

- MANUFACTURED LUMBER, PSL, LVL, AND LSL SHOWN ON PLAN ARE BASED PRODUCTS MANUFACTURED BY THE WEYERHAEUSER CORPORATION IN ACCORDANCE WITH ICC-ES REPORT ESR-1387. MEMBERS SHALL HAVE THE FOLLOWING MINIMUM PROPERTIES:

PSL (2.0E)	Fb = 2900 PSI, E = 2000 KSI, Fv = 290 PSI
LVL (2.0E)	Fb = 2600 PSI, E = 2000 KSI, Fv = 285 PSI
LSL (1.55E)	Fb = 2325 PSI, E = 1550 KSI, Fv = 310 PSI

ALTERNATE MANUFACTURED LUMBER MANUFACTURERS MAY BE USED SUBJECT TO REVIEW AND APPROVAL BY THE ARCHITECT AND STRUCTURAL ENGINEER. ALTERNATE MANUFACTURER'S PRODUCTS SHALL BE COMPATIBLE WITH THE JOIST HANGERS AND OTHER HARDWARE SPECIFIED ON PLANS, OR ALTERNATE HANGERS AND HARDWARE SHALL SUBMITTED FOR REVIEW AND APPROVAL. SUBSTITUTED ITEMS SHALL HAVE ICC-ES REPORT APPROVAL FOR EQUAL OR GREATER LOAD CAPACITIES.

MANUFACTURED LUMBER PRODUCTS SHALL BE INSTALLED WITH A MOISTURE CONTENT OF 12% OR LESS. THE CONTRACTOR SHALL MAKE PROVISIONS DURING CONSTRUCTION TO PREVENT THE MOISTURE CONTENT OF INSTALLED BEAMS FROM EXCEEDING 12%. EXCESSIVE DEFLECTIONS MAY OCCUR IF MOISTURE CONTENT EXCEEDS THIS VALUE.

- PLYWOOD SHEATHING SHALL BE GRADE C-D, EXTERIOR GLUE OR STRUCTURAL II, EXTERIOR GLUE IN CONFORMANCE WITH DOC PS 1 OR PS 2. ORIENTED STRAND BOARD OF EQUIVALENT THICKNESS, EXPOSURE RATING AND PANEL INDEX MAY BE USED IN LIEU OF PLYWOOD.

ROOF SHEATHING SHALL BE 1/2" (NOMINAL) WITH SPAN RATING 32/16.

FLOOR SHEATHING SHALL BE 3/4" (NOMINAL) WITH SPAN RATING 48/24.

WALL SHEATHING SHALL BE 1/2" (NOMINAL) WITH SPAN RATING 24/0.

PROVIDE APPROVED PLYWOOD EDGE CLIPS CENTERED BETWEEN JOISTS/TRUSSES AT UNBLOCKED ROOF SHEATHING EDGES. ALL FLOOR SHEATHING EDGES SHALL HAVE APPROVED T&G JOINTS OR SHALL BE SUPPORTED WITH SOLID BLOCKING. ALLOW 1/8" SPACING AT ALL PANEL EDGES AND ENDS OF FLOOR AND ROOF SHEATHING.

REFER TO WOOD FRAMING NOTES BELOW FOR TYPICAL NAILING REQUIREMENTS.

- ALL WOOD IN DIRECT CONTACT WITH CONCRETE OR MASONRY SHALL BE PRESSURE-TREATED WITH AN APPROVED PRESERVATIVE OR (2) LAYERS OF ASPHALT IMPREGNATED BUILDING PAPER SHALL BE PROVIDED BETWEEN UNTREATED WOOD AND CONCRETE OR MASONRY.

- PRESERVATIVE TREATED WOOD SHALL BE TREATED PER AWPA STANDARD U1 TO THE USE CATEGORY EQUAL TO OR HIGHER THAN THE INTENDED APPLICATION. TREATED WOOD FOR ABOVE GROUND USE SHALL BE TREATED TO AWPA UC3B. WOOD IN CONTINUOUS CONTACT WITH FRESH WATER OR SOIL SHALL BE TREATED TO AWPA UC4A. WOOD FOR USE IN PERMANENT FOUNDATIONS SHALL BE TREATED TO AWPA UC4B.

- FASTENERS AND TIMBER CONNECTORS USED WITH TREATED WOOD SHALL HAVE CORROSION RESISTANCE AS INDICATED IN THE FOLLOWING TABLE, UNLESS OTHERWISE NOTED.

WOOD TREATMENT	CONDITION	PROTECTION
HAS NO AMMONIA CARRIER	INTERIOR DRY	G90 GALVANIZED
CONTAINS AMMONIA CARRIER	INTERIOR DRY	G185 OR A185 HOT DIPPED OR CONTINUOUS HOT-GALVANIZED PER ASTM A653
CONTAINS AMMONIA CARRIER	INTERIOR WET	TYPE 304 OR 316 STAINLESS
CONTAINS AMMONIA CARRIER	EXTERIOR	TYPE 304 OR 316 STAINLESS
AZCA	ANY	TYPE 304 OR 316 STAINLESS

INTERIOR DRY CONDITIONS SHALL HAVE WOOD MOISTURE CONTENT LESS THAN 19%. WOOD MOISTURE CONTENT IN OTHER CONDITIONS (INTERIOR WET, EXTERIOR WET, AND EXTERIOR DRY) IS EXPECTED TO EXCEED 19%. CONNECTORS AND THEIR FASTENERS SHALL BE THE SAME MATERIAL. COMPLY WITH THE TREATMENT MANUFACTURERS RECOMMENDATIONS FOR PROTECTION OF METAL.

- TIMBER CONNECTORS CALLED OUT BY LETTERS AND NUMBERS SHALL BE "STRONG-TIE" BY SIMPSON COMPANY, AS SPECIFIED IN THEIR CATALOG NUMBER C-2015. EQUIVALENT DEVICES BY OTHER MANUFACTURERS MAY BE SUBSTITUTED, PROVIDED THEY HAVE ICC-ES APPROVAL FOR EQUAL OR GREATER LOAD CAPACITIES. PROVIDE NUMBER AND SIZE OF FASTENERS AS SPECIFIED BY MANUFACTURER FOR MAXIMUM LOAD CARRYING CAPACITY. CONNECTORS SHALL BE INSTALLED IN ACCORDANCE WITH THE MANUFACTURER'S RECOMMENDATIONS.

ALL 2X JOISTS SHALL BE CONNECTED TO FLUSH BEAMS WITH "LUS" SERIES JOIST HANGERS. ALL TJI JOISTS SHALL BE CONNECTED TO FLUSH BEAMS WITH "TIS" SERIES JOIST HANGERS. ALL DOUBLE-JOIST BEAMS SHALL BE CONNECTED TO FLUSH BEAMS WITH "WIT" SERIES JOIST HANGERS.

WHERE CONNECTOR STRAPS CONNECT TWO MEMBERS, PLACE ONE-HALF OF THE NAILS OR BOLTS IN EACH MEMBER.

ALL SHIMS SHALL BE SEASONED AND DRIED AND THE SAME GRADE (MINIMUM) AS MEMBERS CONNECTED.

- WOOD FASTENERS

- NAIL SIZES SPECIFIED ON DRAWINGS ARE BASED ON THE FOLLOWING SPECIFICATIONS:

SIZE	LENGTH	DIAMETER
6d	2"	0.113"
8d	2-1/2"	0.131"
10d	3"	0.148"
12d	3-1/4"	0.148"
16d BOX	3-1/2"	0.135"

IF CONTRACTOR PROPOSES THE USE OF ALTERNATE NAILS, THEY SHALL SUBMIT NAIL SPECIFICATIONS TO THE STRUCTURAL ENGINEER (PRIOR TO CONSTRUCTION) FOR REVIEW AND APPROVAL.

NAILS - PLYWOOD (APA RATED SHEATHING) FASTENERS TO FRAMING SHALL BE DRIVEN FLUSH TO FACE OF SHEATHING WITH NO COUNTERSINKING PERMITTED. TOE-NAILS SHALL BE DRIVEN AT AN ANGLE OF 30 DIGRESS WITH THE MEMBER AND STARTED 1/3 THE LENGTH OF THE NAIL FROM THE MEMBER END.

- ALL BOLTS IN WOOD MEMBERS SHALL CONFORM TO ASTM A307. PROVIDE WASHERS UNDER THE HEADS AND NUTS OF ALL BOLTS AND LAG BOLTS BEARING ON WOOD. INSTALLATION OF LAG BOLTS SHALL CONFORM TO THE NATIONAL DESIGN SPECIFICATION FOR WOOD CONSTRUCTION WITH A LEAD BORE HOLE OF 60 TO 70 PERCENT OF THE SHANK DIAMETER. LEAD HOLES ARE NOT REQUIRED FOR 3/8" AND SMALLER LAG SCREWS.

- NOTCHES AND HOLES IN WOOD FRAMING:

A. NOTCHES ON THE ENDS OF SOLID SAWN JOISTS AND RAFTERS SHALL NOT EXCEED ONE-FOURTH THE JOIST DEPTH. NOTCHES IN THE TOP OR BOTTOM OF SOLID SAWN JOISTS SHALL NOT EXCEED ONE-SIXTH THE DEPTH AND SHALL NOT BE LOCATED IN THE MIDDLE THIRD OF THE SPAN. HOLES BORED IN SOLID SAWN JOISTS AND RAFTERS SHALL NOT BE WITHIN 2 INCHES OF THE TOP OR BOTTOM OF THE JOIST, AND THE DIAMETER OF ANY SUCH HOLE SHALL NOT EXCEED ONE-THIRD THE DEPTH OF THE JOIST.

B. IN EXTERIOR WALLS AND BEARING PARTITIONS, ANY WOOD STUD IS PERMITTED TO BE CUT OR NOTCHED TO A DEPTH NOT EXCEEDING 25 PERCENT OF ITS WIDTH. A HOLE NOT GREATER IN DIAMETER THAN 40 PERCENT OF THE STUD WIDTH IS PERMITTED TO BE BORED IN ANY WOOD STUD. IN NO CASE SHALL THE EDGE OF THE BORED HOLE BE NEARER THAN 5/8 INCH TO THE EDGE OF THE STUD. BORED HOLES SHALL NOT BE LOCATED AT THE SAME SECTION OF STUD AS A CUT OR NOTCH.

C. NOTCHES AND HOLES IN MANUFACTURED LUMBER AND PREFABRICATED PLYWOOD WEB JOISTS SHALL BE PER THE MANUFACTURERS RECOMMENDATIONS UNLESS OTHERWISE NOTED.

- WOOD FRAMING NOTES--THE FOLLOWING APPLY UNLESS OTHERWISE SHOWN ON THE PLANS:

A. ALL WOOD FRAMING DETAILS NOT SHOWN OTHERWISE SHALL BE CONSTRUCTED TO THE MINIMUM STANDARDS OF THE INTERNATIONAL BUILDING CODE, THE AITC "TIMBER CONSTRUCTION MANUAL" AND THE AF&PA "NATIONAL DESIGN SPECIFICATION FOR WOOD CONSTRUCTION". MINIMUM NAILING, UNLESS OTHERWISE NOTED, SHALL CONFORM TO IBC TABLE 2304.10.1. COORDINATE THE SIZE AND LOCATION OF ALL OPENINGS WITH MECHANICAL AND ARCHITECTURAL DRAWINGS.

B. WALL FRAMING: REFER ARCHITECTURAL DRAWINGS FOR THE SIZE OF ALL WALLS. ALL STUDS SHALL BE SPACED AT 16" O.C. UNO. TWO STUDS MINIMUM SHALL BE PROVIDED AT THE END OF ALL WALLS AND AT EACH SIDE OF ALL OPENINGS, AND AT BEAM OR HEADER BEARING LOCATIONS. TWO 2x8 HEADERS SHALL BE PROVIDED OVER ALL OPENINGS NOT OTHERWISE NOTED. SOLID BLOCKING FOR WOOD COLUMNS SHALL BE PROVIDED THROUGH FLOORS TO SUPPORTS BELOW. PROVIDE CONTINUOUS SOLID BLOCKING AT MID-HEIGHT OF ALL STUD WALLS OVER 10'-0" IN HEIGHT.

ALL WALLS SHALL HAVE A SINGLE BOTTOM PLATE AND A DOUBLE TOP PLATE. END NAIL TOP PLATE TO EACH STUD WITH TWO 16d NAILS, AND TOENAIL OR END NAIL EACH STUD TO BOTTOM PLATE WITH TWO 16d NAILS. FACE NAIL DOUBLE TOP PLATE WITH 16d @ 12" O.C. AND LAP MINIMUM 4'-0" AT JOINTS AND PROVIDE EIGHT 16d NAILS @ 4" O.C. EACH SIDE JOINT.

ALL STUD WALLS SHALL HAVE THEIR LOWER WOOD PLATES ATTACHED TO WOOD FRAMING BELOW WITH TWO ROWS OF 16d NAILS @ 12" ON-CENTER, OR ATTACHED TO CONCRETE BELOW WITH 5/8" DIAMETER ANCHOR BOLTS @ 4'-0" ON-CENTER EMBEDDED 7" MINIMUM, UNLESS INDICATED OTHERWISE. INDIVIDUAL MEMBERS OF BUILT-UP POSTS SHALL BE NAILED TO EACH OTHER WITH TWO ROWS OF 16d @12" ON-CENTER. UNLESS OTHERWISE NOTED, GYPSUM WALLBOARD SHALL BE FASTENED TO THE INTERIOR SURFACE OF ALL STUDS AND PLATES WITH NO. 6 X 1-1/4" TYPE S OR W SCREWS @ 8" ON-CENTER. UNLESS INDICATED OTHERWISE, 1/2" (NOMINAL) APA RATED SHEATHING (SPAN RATING 24/0) SHALL BE NAILED TO ALL EXTERIOR SURFACES WITH 8d NAILS @ 6" ON-CENTER AT PANEL EDGES AND TOP AND BOTTOM PLATES (BLOCK UN-SUPPORTED EDGES) AND TO ALL INTERMEDIATE STUDS AND BLOCKING WITH 8d Nails @ 12" ON-CENTER ALLOW 1/8" SPACING AT ALL PANEL EDGES AND PANEL ENDS.

C. FLOOR AND ROOF FRAMING: PROVIDE DOUBLE JOISTS UNDER ALL PARALLEL PARTITIONS THAT EXTEND OVER MORE THAN HALF THE JOIST LENGTH AND AROUND ALL OPENINGS IN FLOORS OR ROOFS UNLESS OTHERWISE NOTED. PROVIDE SOLID BLOCKING AT ALL BEARING POINTS. TOE-NAIL JOISTS TO SUPPORTS WITH TWO 16d NAILS. ATTACH TIMBER JOISTS TO FLUSH HEADERS OR BEAMS WITH SIMPSON METAL JOIST HANGERS IN ACCORDANCE WITH NOTES ABOVE. NAIL ALL MULTI JOIST BEAMS TOGETHER WITH TWO ROWS 16d @ 12" ON-CENTER.

UNLESS OTHERWISE NOTED ON THE PLANS, PLYWOOD ROOF AND FLOOR SHEATHING SHALL BE LAID UP WITH GRAIN PERPENDICULAR TO SUPPORTS AND NAILED AT 6" ON-CENTER WITH 8d NAILS TO FRAMED PANEL EDGES, STRUTS AND OVER STUD WALLS AS SHOWN ON PLANS AND @ 12" ON-CENTER TO INTERMEDIATE SUPPORTS. PROVIDE APPROVED PLYWOOD EDGE CLIPS CENTERED BETWEEN JOISTS/TRUSSES AT UNBLOCKED ROOF SHEATHING EDGES. ALL FLOOR SHEATHING EDGES SHALL HAVE APPROVED T&G JOINTS OR SHALL BE SUPPORTED WITH SOLID BLOCKING. ALLOW 1/8" SPACING AT ALL PANEL EDGES AND ENDS OF FLOOR AND ROOF SHEATHING. TOENAIL BLOCKING TO SUPPORTS WITH 16d @ 12" ON-CENTER UNLESS OTHERWISE NOTED.

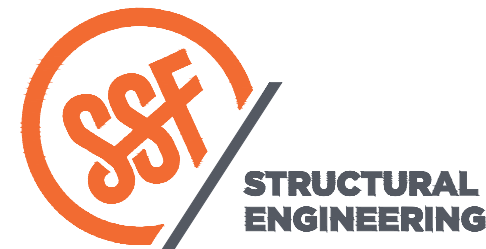

2124 Third Avenue - Suite 100 - Seattle, WA 98121
P: 206.443.6212
ssfengineers.com

934 Broadway - Tacoma, WA 98402
P: 253.284.9470
ssfengineers.com

Copyright 2018 Swenson Say Fagert - All Rights Reserved

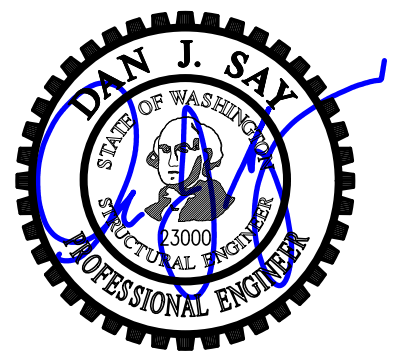

DRAWN: RJ
DESIGN: KWW
CHECKED: KMR
APPROVED: DJS

REVISIONS:

DPD:

PROJECT TITLE:

LBH Residence
7450 North Mercer Way
Mercer Island, WA

ARCHITECT:

Stillwell Hanson Architects
46 Etruria Street, Suite 200
Seattle, WA 98109
PH 206 297 1504

ISSUE:

Permit

SHEET TITLE:

General Structural Notes

SCALE:

DATE: **November 30, 2018**

PROJECT NO: **00834-2018-08**

SHEET NO:

S1.1



DRAWN: RJ
 DESIGN: KWW
 CHECKED: KMR
 APPROVED: DJS

REVISIONS:

DPD:

PROJECT TITLE:
LBH Residence
 7450 North Mercer Way
 Mercer Island, WA

ARCHITECT:
Stillwell Hanson Architects
 46 Etruria Street, Suite 200
 Seattle, WA 98109
 PH 206 297 1504

ISSUE:
Permit

SHEET TITLE:
Foundation Plan

SCALE: 1/4" = 1'-0"
 DATE: November 30, 2018
 PROJECT NO: 00834-2018-08
 SHEET NO:

S2.1

Plan Notes

- DO NOT SCALE DRAWINGS. REFER TO ARCHITECTURAL DRAWINGS FOR ALL DIMENSIONS.
- THE BOTTOM OF ALL EXTERIOR FOOTINGS SHALL BE 18" MINIMUM BELOW GRADE.
- 4" CONCRETE SLAB OVER 6 MIL VAPOR BARRIER ON 4" OF GRAVEL OR CRUSHED ROCK OVER FIRM UNDISTURBED SOIL OR ENGINEERED COMPACTED BACK-FILL. REINFORCE #3 AT 16"OC EACH WAY, CENTERED. PROVIDE CONSTRUCTION/CONTROL JOINTS PER DETAIL 12/S3.1.
- PROVIDE CORNER BARS PER DETAIL 8/S3.1 AT ALL WALL AND FOOTING INTERSECTIONS.
- ALL POSTS ABOVE SHALL BEAR FULLY ON BEAMS OR POSTS BELOW AND SHALL HAVE CONTINUOUS FULL BEARING THROUGH FLOORS TO THE FOUNDATION.
- PROVIDE EPOXY GROUTED #4 X 2'-6" DOWELS EMBEDDED A MINIMUM OF 6" IN TO EXISTING CONCRETE TO MATCH NEW HORIZONTAL REINFORCING. TYPICAL WHERE NEW CONCRETE WALL OR FOOTING TERMINATES AT EXISTING CONCRETE. EPOXY GROUT PER GENERAL STRUCTURAL NOTES.
- CONTRACTOR SHALL VERIFY ALL EXISTING FRAMING CALLED OUT ON PLAN. IF DISCREPANCIES ARE FOUND, CONTRACTOR SHALL NOTIFY ENGINEER OF RECORD IMMEDIATELY.
- REFER TO GENERAL STRUCTURAL NOTES FOR ADDITIONAL REQUIREMENTS.

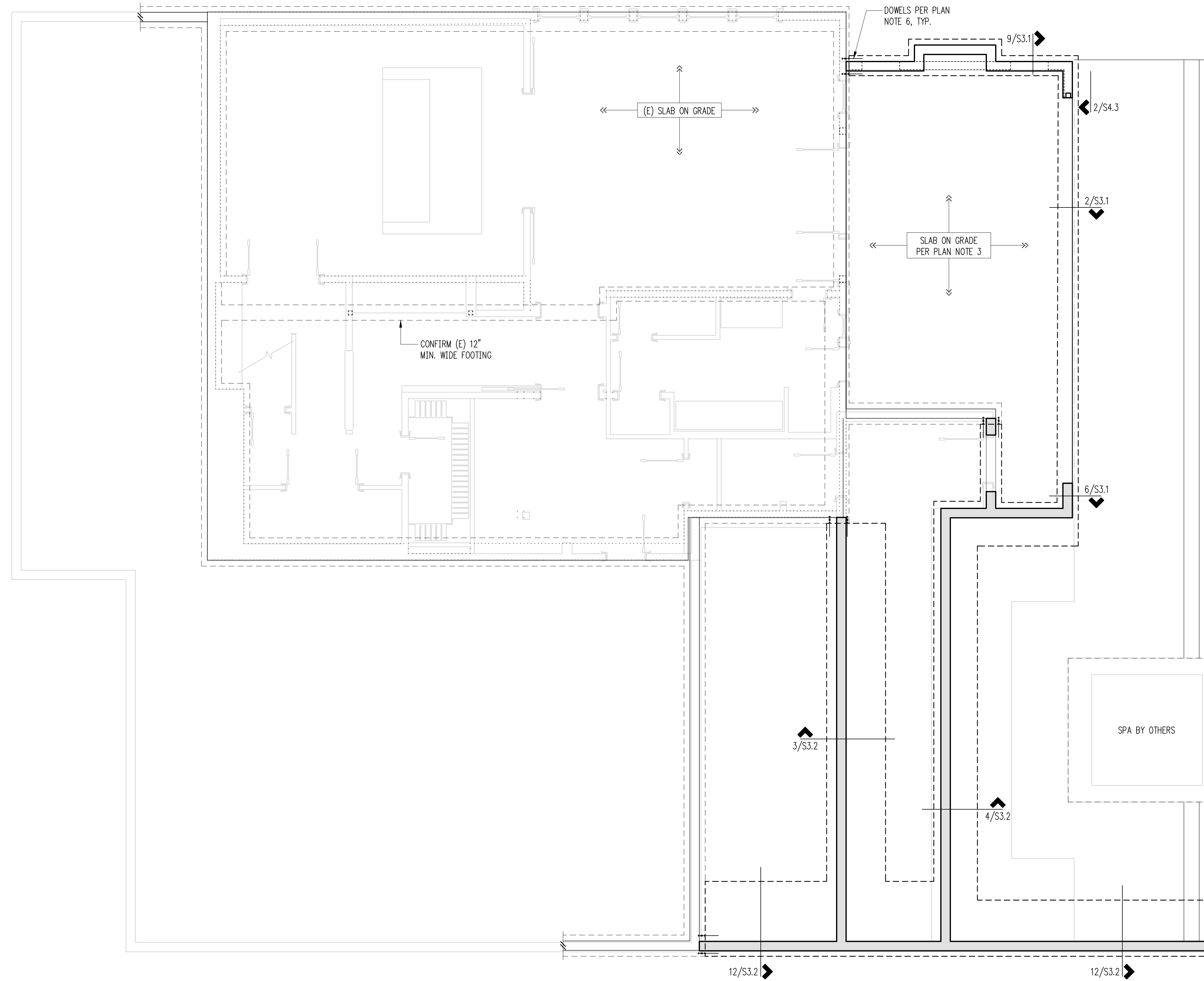

Foundation Plan
 Scale: 1/4" = 1'-0"

Plan Notes

- DO NOT SCALE DRAWINGS. REFER TO ARCHITECTURAL DRAWINGS FOR ALL DIMENSIONS.
- FLOOR SHEATHING SHALL BE 3/4" TONGUE AND GROOVE A.P.A. RATED PANELS (EXPOSURE 1, SPAN RATING 48/24). GLUE AND NAIL AT ALL FRAMED PANEL EDGES WITH 8D AT 6" O.C. AND TO ALL INTERMEDIATE FRAMING AT 12" O.C.
- HEADERS OVER DOOR AND WINDOW OPENINGS SHALL BE (2) 2x8 MINIMUM. PROVIDE (2) TRIMMER STUDS (MINIMUM) AT EACH END OF ALL HEADERS UNLESS NOTED OTHERWISE ON PLANS. SEE DETAIL 6/S4.1 FOR TYPICAL INSTALLATION.
- PROVIDE (2) STUDS (MINIMUM) AT EACH END OF ALL BEAMS UNLESS NOTED OTHERWISE ON PLANS. BEAR BEAM FULLY ON BUILT UP COLUMN AND PROVIDE AC, PC, OR LPC CAP.
- MANUFACTURED LUMBER PRODUCTS (LSL, LVL, PSL, GL) SHALL BE INSTALLED WITH A MOISTURE CONTENT OF 12% OR LESS. THE CONTRACTOR SHALL MAKE PROVISIONS DURING CONSTRUCTION TO PREVENT THE MOISTURE CONTENT OF INSTALLED BEAMS FROM EXCEEDING 12%.
- ALL POSTS ABOVE SHALL BEAR FULLY ON BEAMS OR POSTS BELOW AND SHALL HAVE CONTINUOUS FULL BEARING THROUGH FLOORS TO THE FOUNDATION.
- SPLICE ALL TOP PLATE SPLICES PER DETAIL 10/S4.1.
- PROVIDE EPOXY GROUTED #4 X 2'-6" DOWELS EMBEDDED A MINIMUM OF 6" IN TO EXISTING CONCRETE TO MATCH NEW HORIZONTAL REINFORCING. TYPICAL WHERE NEW CONCRETE WALL OR FOOTING TERMINATES AT EXISTING CONCRETE. EPOXY GROUT PER GENERAL STRUCTURAL NOTES.
- CONTRACTOR SHALL VERIFY ALL EXISTING FRAMING CALLED OUT ON PLAN. IF DISCREPANCIES ARE FOUND, CONTRACTOR SHALL NOTIFY ENGINEER OF RECORD IMMEDIATELY.
- REFER TO GENERAL STRUCTURAL NOTES FOR ADDITIONAL REQUIREMENTS.

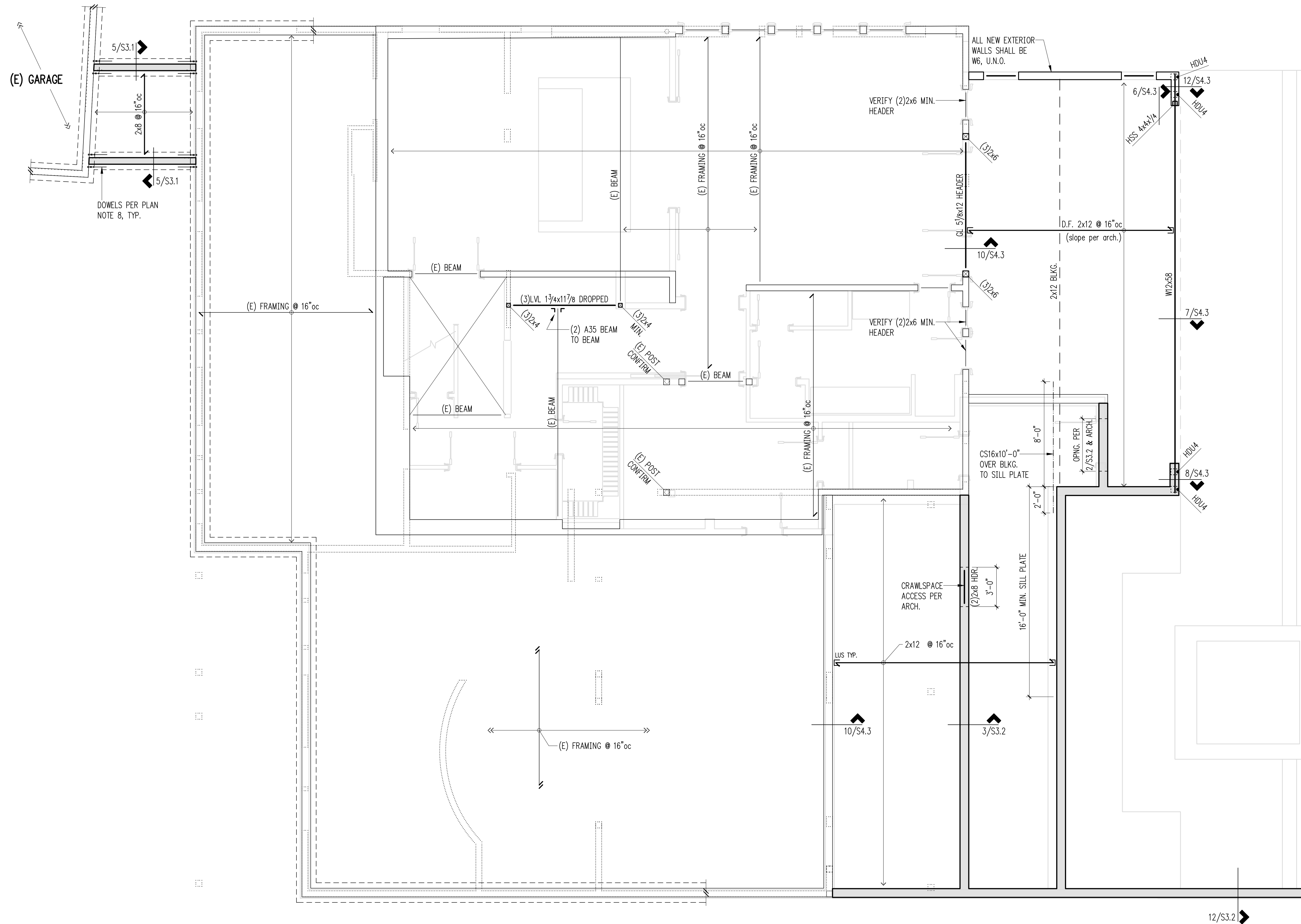

Main Floor Framing Plan
Scale: 1/4" = 1'-0"

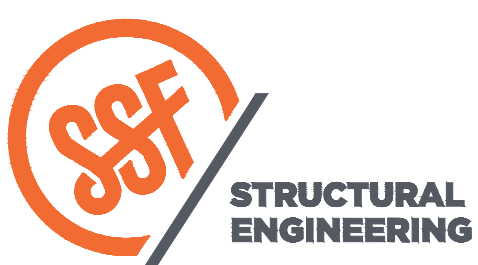

1124 Third Avenue - Suite 100 - Seattle, WA 98121
P: 206.443.6212
ssfengineers.com

934 Broadway - Tacoma, WA 98402
P: 253.284.9470
ssfengineers.com

Copyright 2018 Swenson Say Fajét - All Rights Reserved

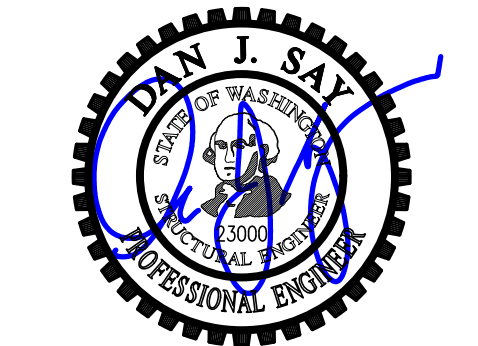

DRAWN: RJ
DESIGN: KWW
CHECKED: KMR
APPROVED: DJS

REVISIONS:

DPD:

PROJECT TITLE:
LBH Residence
7450 North Mercer Way
Mercer Island, WA

ARCHITECT:
Stillwell Hanson Architects
46 Etruria Street, Suite 200
Seattle, WA 98109
PH 206 297 1504

ISSUE:
Permit

SHEET TITLE:
Main Floor Framing Plan

SCALE: 1/4" = 1'-0"
DATE: November 30, 2018
PROJECT NO: 00834-2018-08
SHEET NO:

S2.2

ALTA/NSPS LAND TITLE SURVEY

measure success

BASIS OF BEARINGS

HELD BEARING OF N 00°03'00" W ALONG N-S LINE OF SEC. 1, T.24N., R.4E., W.M. AS SHOWN HEREON AND PER MERCER ISLAND LOT LINE REVISION NO. MI 96-1381 IN VOL. 116 OF SURVEYS, PG 34

REFERENCES

R1. RECORD OF SURVEY, VOL. 116, PG. 034, RECORDS OF KING COUNTY, WASHINGTON.

SURVEYOR'S NOTES

- THE SURVEY SHOWN HEREON WAS PERFORMED IN MARCH OF 2018. THE FIELD DATA WAS COLLECTED AND RECORDED ON MAGNETIC MEDIA THROUGH AN ELECTRONIC THEODOLITE. THE DATA FILE IS ARCHIVED ON DISC OR CD. WRITTEN FIELD NOTES MAY NOT EXIST.
- ALL MONUMENTS SHOWN HEREON WERE LOCATED DURING THE COURSE OF THIS SURVEY UNLESS OTHERWISE NOTED.
- SUBJECT PROPERTY TAX PARCEL NO. 531510-0125.
- APPROXIMATE SUBJECT PROPERTY UPLAND AREA IS: 30,945 SQ FT +/- (0.71 ACRES)
- FIELD DATA FOR THIS SURVEY WAS OBTAINED BY DIRECT FIELD MEASUREMENTS WITH A CALIBRATED ELECTRONIC 5-SECOND TOTAL STATION AND/OR SURVEY GRADE GPS OBSERVATIONS. ALL ANGULAR AND LINEAR RELATIONSHIPS ARE ACCURATE AND MEET THE STANDARDS SET BY WAC 332-130-090.
- THE PROPERTY DESCRIBED HEREON IS THE SAME AS THE PROPERTY DESCRIBED IN CW TITLE COMPANY, COMMITMENT NO. CK 40190740, WITH AN EFFECTIVE DATE OF JANUARY 29, 2018 AND THAT ALL EASEMENTS, COVENANTS AND RESTRICTIONS REFERENCED IN SAID TITLE COMMITMENT OR APPARENT FROM A PHYSICAL INSPECTION OF THE PROPERTY OR OTHERWISE KNOWN TO ME HAVE BEEN PLOTTED HEREON OR OTHERWISE NOTED AS TO THEIR EFFECT ON THE PROPERTY.
- THE PROPERTY IS LOCATED WITHIN AN AREA HAVING A ZONE DESIGNATION "X", PER THE FEDERAL EMERGENCY MANAGEMENT AGENCY (FEMA), ON FLOOD INSURANCE RATE MAP NO. "NOT PRINTED", IN KING COUNTY, STATE OF WASHINGTON, WHICH IS THE CURRENT FLOOD INSURANCE RATE MAP FOR THE COMMUNITY IN WHICH THE PROPERTY IS SITUATED.
- ZONING REPORT NOT PROVIDED PER ITEM 6 (a) ALTA/NSPS LAND TITLE SURVEY. OPTIONAL SURVEY RESPONSIBILITIES AND SPECIFICATIONS
- THE TOTAL NUMBER OF STRIPED PARKING SPACES ON THE PROPERTY IS 2 (GARAGE), INCLUDING 0 DESIGNATED DISABLED SPACES.
- THERE IS NO OBSERVED EVIDENCE OF CURRENT EARTH MOVING WORK, BUILDING CONSTRUCTION OR BUILDING ADDITIONS AT THE PROPERTY.
- THERE WAS NO INFORMATION PROVIDED TO US BY THE CONTROLLING JURISDICTION OF PROPOSED CHANGES TO STREET RIGHT OF WAY LINES, NOR ANY OBSERVED EVIDENCE OF RECENT STREET OR SIDEWALK CONSTRUCTION OR REPAIRS AT THE TIME OF OUR SURVEY.
- THERE WAS NO OBSERVED EVIDENCE OF WETLANDS OR WETLAND DELINEATION MARKERS FOUND AT THE TIME OF OUR SURVEY.

LEGAL DESCRIPTION

LOT 9, BLOCK 2, MCGILVRA' S ISLAND ADDITION ACCORDING TO THE PLAT THEREOF, RECORDED IN VOLUME 16 OF PLATS, PAGE 58, IN KING COUNTY, WASHINGTON. THE EASTERLY BOUNDARY LINE OF WHICH IS ESTABLISHED BY JUDGMENT AND DECREE IN THE SUPERIOR COURT OF THE STATE OF WASHINGTON, CASE NUMBER 582636, DATED AUGUST 8, 1962, SAID BOUNDARY LINE BEING DESCRIBED AS FOLLOWS:

BEGINNING AT A POINT ON THE SOUTH LINE, BLOCK 2, MCGILVRA' S ISLAND ADDITION, SAID POINT BEING WEST A DISTANCE OF 104.13 FEET FROM THE SOUTHEAST CORNER OF SAID BLOCK, THENCE NORTH 10°57'20" EAST 91.90 FEET, THENCE NORTH 3°09'00" EAST 9.30 FEET, THENCE NORTH 4°36'00" EAST 65.20 FEET, THENCE NORTH 9°06'00" EAST 38.00 FEET, THENCE NORTH 5°10'30" EAST 60.87 FEET, THENCE NORTH 7°45'36" EAST 118 FEET, MORE OR LESS, TO THE SHORE LINE OF LAKE WASHINGTON,

TOGETHER WITH SECOND CLASS SHORELANDS ADJOINING

SITUATE IN THE CITY OF MERCER ISLAND, COUNTY OF KING, STATE OF WASHINGTON.

SCHEDULE B ITEMS

- NOTICE OF TAP OR CONNECTION CHARGES WHICH HAVE BEEN OR WILL BE DUE IN CONNECTION WITH DEVELOPMENT OR RE-DEVELOPMENT OF THE LAND AS DISCLOSED BY RECORDED INSTRUMENT. INQUIRIES REGARDING THE SPECIFIC AMOUNT OF THE CHARGES SHOULD BE MADE TO THE CITY/COUNTY/AGENCY. CITY/COUNTY/AGENCY: CITY OF MERCER ISLAND. RECORDED: DECEMBER 6, 1977. RECORDING NO.: 7712060812 (NOT SURVEY RELATED)
- EASEMENT AND THE TERMS AND CONDITIONS THEREOF: GRANTEE: MERCER ISLAND SEWER DISTRICT. PURPOSE: CONSTRUCT AND MAINTAIN 2 SEWER LINES LAID SIDE BY SIDE IN SMALL TRENCH AND ALL NECESSARY APPURTENANCES. AREA AFFECTED: OVER PORTION SECOND CLASS SHORELANDS. RECORDED: JANUARY 18, 1956. RECORDING NO.: 4655703 (BLANKET IN NATURE, OVER 2ND CLASS SHORELANDS ADJOINING, NOT PLOTTABLE)
- EASEMENT AND THE TERMS AND CONDITIONS THEREOF: GRANTEE: MUNICIPALITY OF METROPOLITAN SEATTLE. PURPOSE: SEWER TRUNK LINES WITH MANHOLES. AREA AFFECTED: A PORTION OF SAID PREMISES. RECORDED: NOVEMBER 06, 1968. RECORDING NO.: 6430422 (PLOTTED)
- RESTRICTIVE COVENANT NONUSE OF ACCESSORY DWELLING UNIT AND THE TERMS AND CONDITIONS THEREOF: RECORDED: JANUARY 05, 2006. RECORDING NO.: 20060105000287 (NOT SURVEY RELATED)
- INDEMNIFICATION AND HOLD HARMLESS AGREEMENT AND THE TERMS AND CONDITIONS THEREOF: RECORDED: APRIL 6, 2009. RECORDING NO.: 200904060000391 (NOT SURVEY RELATED)
- JOINT AGREEMENT FOR ADJACENT MOORAGE FACILITY AND BOAT LIFT AND THE TERMS AND CONDITIONS THEREOF: RECORDED: FEBRUARY 25, 2015. RECORDING NO.: 20150225001395 (AGREEMENT FOR DOCK, BLANKET IN NATURE, NOT PLOTTABLE)
- LOCATION OF LATERAL BOUNDARIES OF SECOND CLASS SHORELANDS UNDEFINABLE PER ITEM 12, SCHEDULE B

VERTICAL DATUM

NAVD88 PER GPS OBSERVATIONS
SITE BENCHMARK IN ASPHALT DRIVEWAY NEAR SOUTH END OF LOT AS SHOWN ON DRAWING
MASONRY NAIL IN ASPHALT ELEV=52.44'

VICINITY MAP

N.T.S.



LEGEND

	FOUND CASSED CONCRETE MONUMENT		TREE (TYPE, SIZE)
	FOUND REBAR & CAP / IRON PIPE		FIRE HYDRANT
	BENCHMARK		WATER METER
	GAS METER		WATER VALVE
	GAS VALVE		FENCE (WIRE)
	MAIL BOX		FENCE (WOOD)
	POST		GAS LINE
	AIR CONDITIONING UNIT		POWER LINE (OVERHEAD)
	POWER HAND HOLE		SEWER LINE
	POWER METER		DRAINAGE LINE
	POWER POLE		WATER LINE
	POWER TRANSFORMER		BUILDING
	SEWER CLEANOUT		RETAINING WALL
	SEWER HAND HOLE		ASPHALT SURFACE
	SEWER MANHOLE		CONCRETE SURFACE
	AREA DRAIN		DECK / DOCK
	CATCH BASIN (TYPE 1)		SLATE SURFACE
	CATCH BASIN (CURB INLET)		GRAVEL SURFACE
	DRAINAGE MANHOLE		ROCKERY
			ITEM 5 - 10' SEWER ESM/T RFC. NO. 6430422

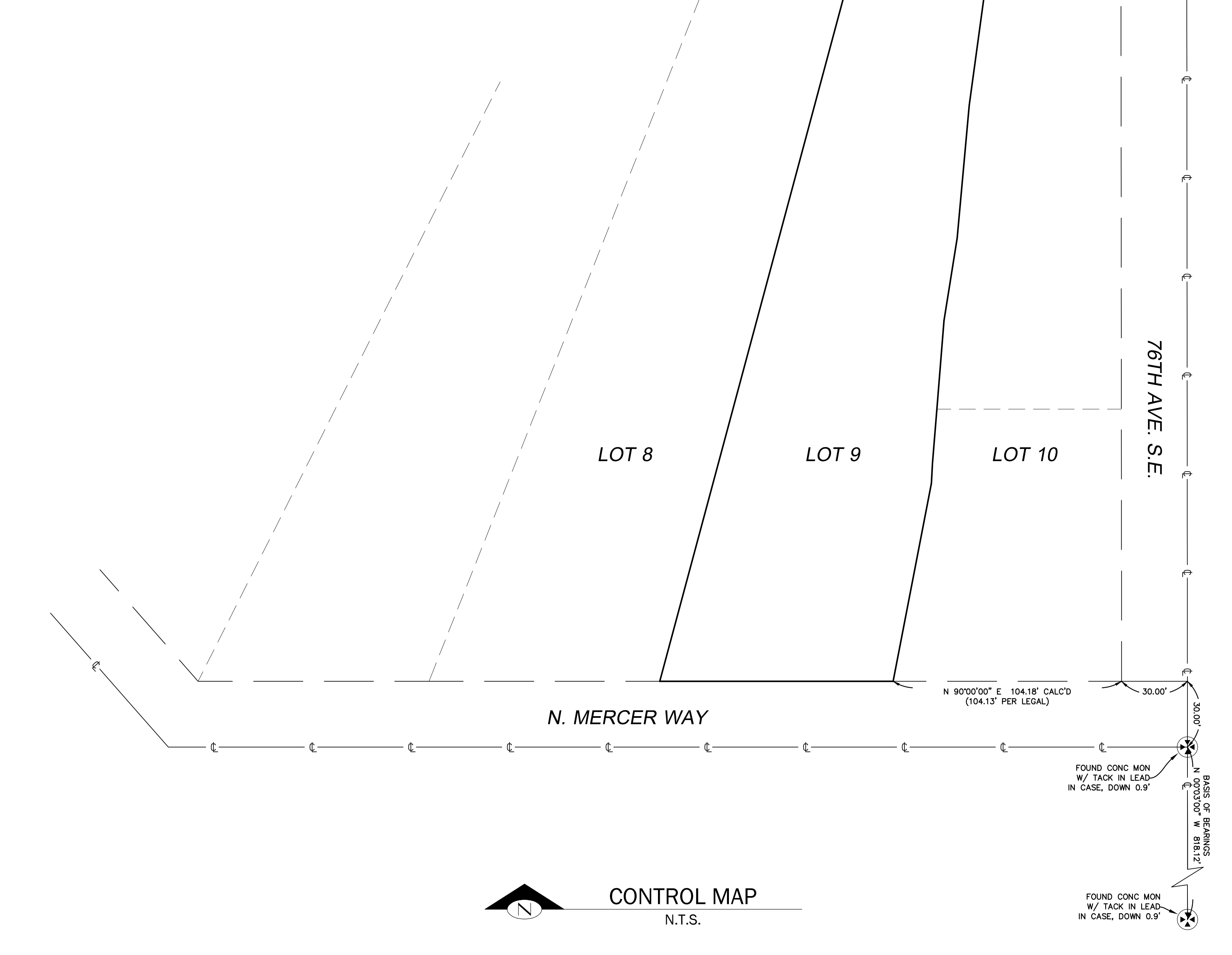

SURVEYOR'S CERTIFICATE

TO: SEAN DAVIS KELL & LORI ANN KELL AND FIRST AMERICAN TITLE COMPANY;

THIS IS TO CERTIFY THAT THIS MAP OR PLAT AND THE SURVEY ON WHICH IT IS BASED WERE MADE IN ACCORDANCE WITH THE 2016 MINIMUM STANDARD DETAIL REQUIREMENTS FOR ALTA/NSPS LAND TITLE SURVEYS, JOINTLY ESTABLISHED AND ADOPTED BY ALTA AND NSPS, AND INCLUDES ITEMS 1, 2, 3, 4, 5, 6(o), 7(a), 7(b)(1), 7(c), 8, 9, 11, 13, AND 16, OF TABLE A, THEREOF. THE FIELD WORK WAS COMPLETED ON MARCH 19, 2018.

Ed J. Green Jr. 12/05/18
EDWIN J. GREEN JR. CERTIFICATE NO. 15025 DATE

ALTA/NSPS LAND TITLE SURVEY
SE 1/4 OF SW 1/4 SEC 1, TWP. 24 N., RGE. 4 E., W.M.
TAX PARCEL NO. 531510-0125
7450 N. MERCER WAY
MERCER ISLAND ~ WASHINGTON ~ 98040



Terrane
10801 Main Street, Suite 102, Bellevue, WA 98004
phone 425.458.4488 support@terrane.net
www.terrane.net

JOB NUMBER:	180467
DATE:	3/27/18
DRAFTED BY:	RLS
CHECKED BY:	EJG/TMM
SCALE:	N.T.S.
REVISION HISTORY	
SHEET NUMBER	
1 OF 2	

ALTA/NSPS LAND TITLE SURVEY

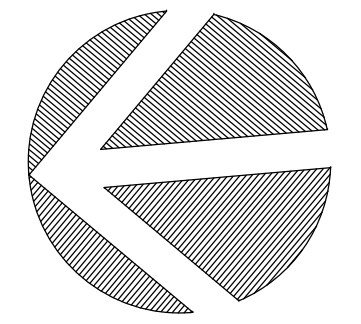

(IN FEET)
1 INCH = 20 FT.

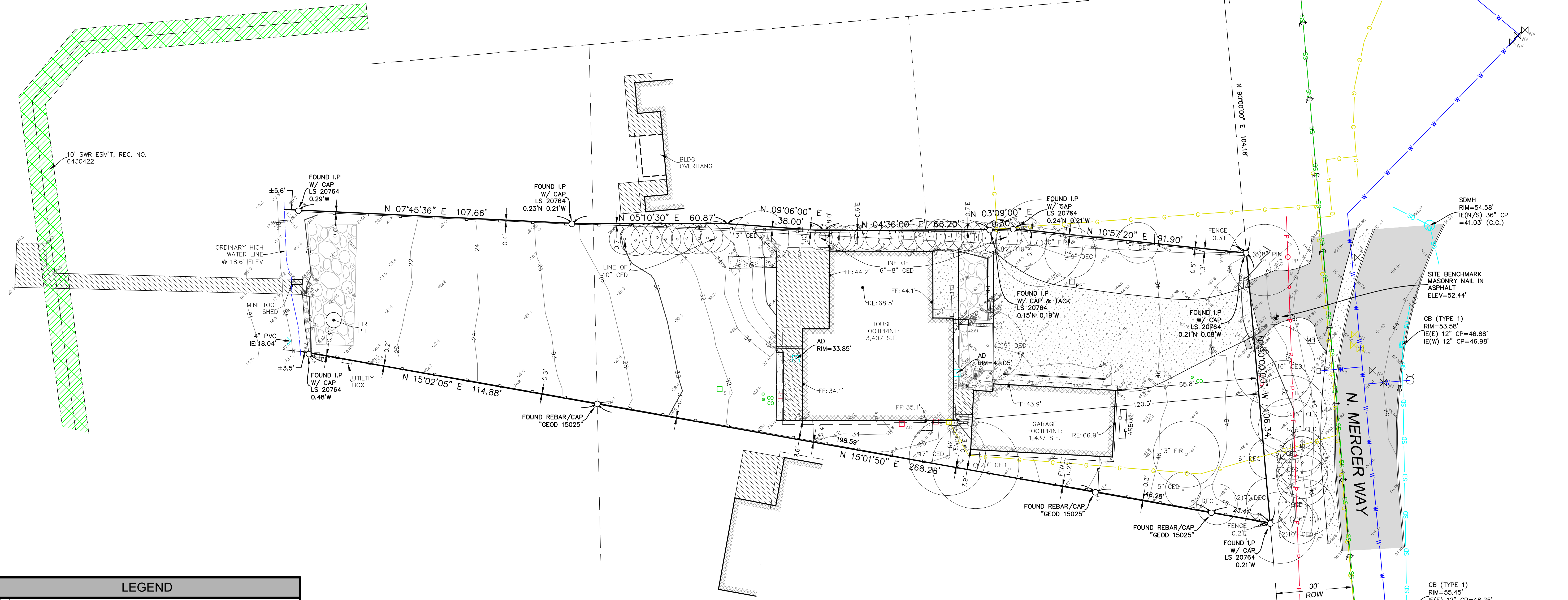

LEGEND

- | | | | |
|--|-----------------------------|--|--|
| | FOUND CASED CONCRETE MONUM | | TREE (TYPE, SIZE) |
| | FOUND REBAR & CAP / IRON PI | | FIRE HYDRANT |
| | BENCHMARK | | WATER METER |
| | GAS METER | | WATER VALVE |
| | GAS VALVE | | FENCE (WIRE) |
| | MAIL BOX | | FENCE (WOOD) |
| | POST | | GAS LINE |
| | AIR CONDITIONING UNIT | | POWER LINE (OVERHEAD) |
| | POWER HAND HOLE | | SEWER LINE |
| | POWER METER | | DRAINAGE LINE |
| | POWER POLE | | WATER LINE |
| | POWER TRANSFORMER | | BUILDING |
| | SEWER CLEANOUT | | RETAINING WALL |
| | SEWER HAND HOLE | | ASPHALT SURFACE |
| | SEWER MANHOLE | | CONCRETE SURFACE |
| | AREA DRAIN | | DECK / DOCK |
| | CATCH BASIN (CURB INLET) | | SLATE SURFACE |
| | DRAINAGE MANHOLE | | GRAVEL SURFACE |
| | | | ROCKERY |
| | | | ITEM 5 - 10' SEWER ESM'T
REC. NO. 6430422 |

measure success

ALTA/NSPS LAND TITLE SURVEY
SE 1/4 OF SW 1/4 SEC 1, TWP. 24 N., RGE. 4 E., W.M.
TAX PARCEL NO. 631510-0125
7450 N MERCER WAY
MERCER ISLAND ~ WASHINGTON ~ 98040

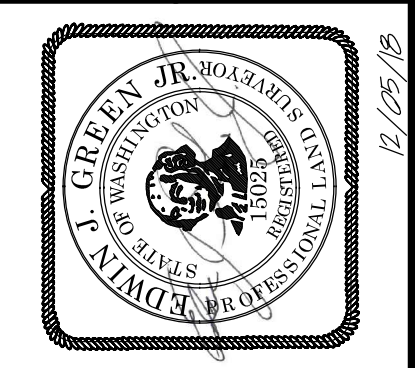

Terrane
10801 Main Street, Suite 102, Bellevue, WA 98004
phone 425.458.4498 support@terrane.net
www.terrane.net

JOB NUMBER:	180467
DATE:	3/26/18
DRAFTED BY:	RLS
CHECKED BY:	EJG/TMM
SCALE:	1" = 20'
REVISION HISTORY	
SHEET NUMBER	
2 OF 2	