

1/4 NE, SEC 11, TWP 24N, RGE 4E, W.M.
2825 W MERCER WAY
PRELIMINARY PLAT

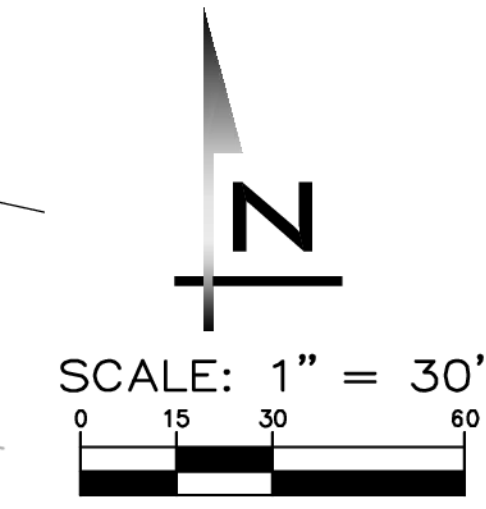
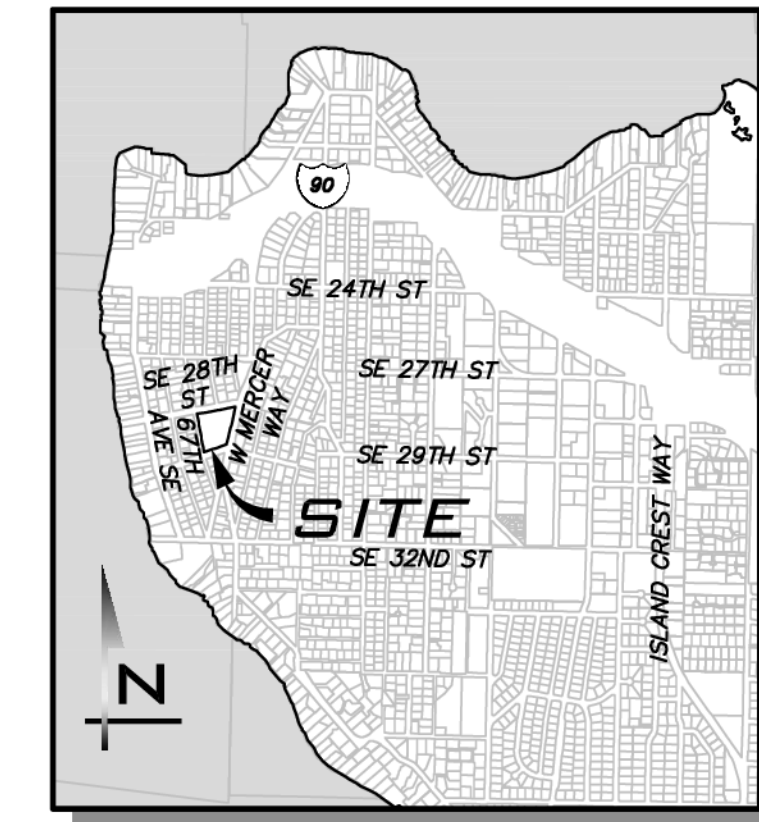

SCALE: AS NOTED
 PROJECT MANAGER: BRETT K PUDISTS, PE
 PROJECT ENGINEER: LYNDEY FEDAK, PE
 DESIGNER: AARON C LANCE
 ISSUE DATE: 2/16/2023

PROJECT TEAM
APPLICANT
 DB MERCER ISLAND PROPERTIES, LLC
 P.O. BOX 726
 101-118TH AVE SE
 BELLEVUE, WA 98009
 (206) 604-7941
 CONTACT: ERIC HANSEN
 EMAIL: ERIC@HANSENRE.COM

CIVIL ENGINEER
 THE BLUELINE GROUP
 25 CENTRAL WAY, SUITE 400
 KIRKLAND, WA 98033
 (425) 250-7247
 CONTACT: BRETT K. PUDISTS, PE
 EMAIL: BRUPUDISTS@THEBLUELINEGROUP.COM

LANDSCAPE ARCHITECT
 THE BLUELINE GROUP
 25 CENTRAL WAY, SUITE 400
 KIRKLAND, WA 98033
 (425) 250-7230
 CONTACT: TC COLLIERAN, RLA
 EMAIL: TCOLLERAN@THEBLUELINEGROUP.COM

SURVEYOR
 4 SITE SURVEYING & CONSULTING
 1336 57TH DRIVE SE
 AUBURN, WA 98002
 (206) 832-9159
 CONTACT: STEVEN AZELINTINE, PLS
 EMAIL: 4SITESURVEYING@COMCAST.NET

ARBORIST
 GREENFOREST INC
 4547 S LUCILE ST
 SEATTLE, WA 98118
 (206) 723-0656
 CONTACT: FAVERO GREENFOREST
 EMAIL: GREENFORESTINC@MINDSPRING.COM

GEOTECHNICAL ENGINEER
 EARTH SOLUTIONS NW, LLC
 1805 136TH PL NE, SUITE 201
 BELLEVUE, WA 98005
 (425) 445-4704
 CONTACT: ADAM SHIER, GIT
 EMAIL: ADAM.SHIER@EARTHSOLUTIONSNW.COM

NO	DATE	BY	REASON FOR CITY COMMENTS	REVISED PER CITY COMMENTS
1	7/22/21	MWK		
2	10/12/21	MWK		
3	2/16/23	MWK		

COVER SHEET
2825 W MERCER WAY
PRELIMINARY PLAT
 PARCEL #2174502425
 CITY OF MERCER ISLAND WASHINGTON

2/16/23
 JOB NUMBER:
13-118
 SHEET NAME:
CV-01
 SHT 1 OF 9

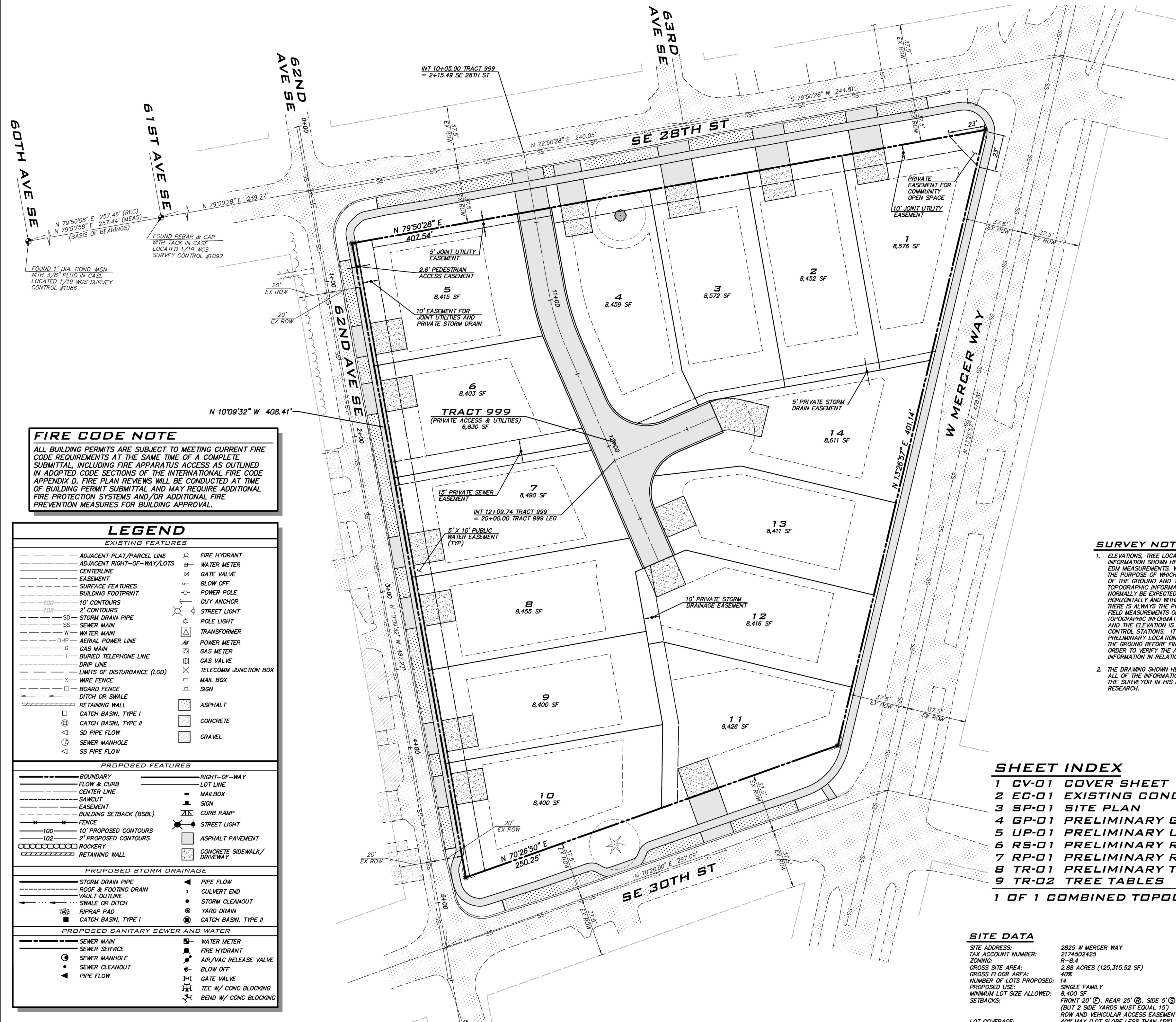

FIRE CODE NOTE
 ALL BUILDING PERMITS ARE SUBJECT TO MEETING CURRENT FIRE CODE REQUIREMENTS AT THE SAME TIME OF A COMPLETE SUBMITTAL, INCLUDING FIRE APPARATUS ACCESS AS OUTLINED IN ADOPTED CODE SECTIONS OF THE INTERNATIONAL FIRE CODE APPENDIX D. FIRE PLAN REVIEWS WILL BE CONDUCTED AT TIME OF BUILDING PERMIT SUBMITTAL AND MAY REQUIRE ADDITIONAL FIRE PROTECTION SYSTEMS AND/OR ADDITIONAL FIRE PREVENTION MEASURES FOR BUILDING APPROVAL.

LEGEND
 EXISTING FEATURES

--- ADJACENT PLAT/PARCEL LINE	--- ADJACENT RIGHT-OF-WAY/LOTS CENTERLINE	--- EASEMENT	--- SURFACE FEATURES	--- BUILDING FOOTPRINT	--- 10' CONTOURS	--- 2' CONTOURS	--- SD STORM DRAIN PIPE	--- SS SEWER MAIN	--- W WATER MAIN	--- OHP AERIAL POWER LINE	--- G GAS MAIN	--- T BURIED TELEPHONE LINE	--- DRIP LINE	--- LIMITS OF DISTURBANCE (LOD)	--- X WIRE FENCE	--- BOARD FENCE	--- DITCH OR SWALE	--- RETAINING WALL	--- CATCH BASIN, TYPE I	--- CATCH BASIN, TYPE II	--- SD PIPE FLOW	--- SEWER MANHOLE	--- SS PIPE FLOW	--- FIRE HYDRANT	--- WATER METER	--- GATE VALVE	--- BLOW OFF	--- POWER POLE	--- GUY ANCHOR	--- STREET LIGHT	--- POLE LIGHT	--- TRANSFORMER	--- POWER METER	--- GAS METER	--- GAS VALVE	--- TELECOMM JUNCTION BOX	--- MAIL BOX	--- SIGN	--- ASPHALT	--- CONCRETE	--- GRAVEL
-------------------------------	---	--------------	----------------------	------------------------	------------------	-----------------	-------------------------	-------------------	------------------	---------------------------	----------------	-----------------------------	---------------	---------------------------------	------------------	-----------------	--------------------	--------------------	-------------------------	--------------------------	------------------	-------------------	------------------	------------------	-----------------	----------------	--------------	----------------	----------------	------------------	----------------	-----------------	-----------------	---------------	---------------	---------------------------	--------------	----------	-------------	--------------	------------

PROPOSED FEATURES

--- BOUNDARY	--- FLOW & CURB	--- CENTER LINE	--- SAWCUT	--- EASEMENT	--- BUILDING SETBACK (BSBL)	--- FENCE	--- 10' PROPOSED CONTOURS	--- 2' PROPOSED CONTOURS	--- ROCKERY	--- RETAINING WALL	--- RIGHT-OF-WAY LOT LINE	--- MAILBOX	--- SIGN	--- CURB RAMP	--- STREET LIGHT	--- ASPHALT PAVEMENT	--- CONCRETE SIDEWALK/ DRIVEWAY
--------------	-----------------	-----------------	------------	--------------	-----------------------------	-----------	---------------------------	--------------------------	-------------	--------------------	---------------------------	-------------	----------	---------------	------------------	----------------------	---------------------------------

PROPOSED STORM DRAINAGE

--- STORM DRAIN PIPE	--- ROOF & FOOTING DRAIN	--- VAULT OUTLINE	--- SWALE OR DITCH	--- RIPRAP PAD	--- CATCH BASIN, TYPE I	--- PIPE FLOW	--- CULVERT END	--- STORM CLEANOUT	--- YARD DRAIN	--- CATCH BASIN, TYPE II
----------------------	--------------------------	-------------------	--------------------	----------------	-------------------------	---------------	-----------------	--------------------	----------------	--------------------------

PROPOSED SANITARY SEWER AND WATER

--- SEWER MAIN	--- SEWER SERVICE	--- SEWER MANHOLE	--- SEWER CLEANOUT	--- PIPE FLOW	--- WATER METER	--- FIRE HYDRANT	--- AIR/VAC RELEASE VALVE	--- BLOW OFF	--- GATE VALVE	--- TEE W/ CONC BLOCKING	--- BEND W/ CONC BLOCKING
----------------	-------------------	-------------------	--------------------	---------------	-----------------	------------------	---------------------------	--------------	----------------	--------------------------	---------------------------

SURVEY NOTES

- ELEVATIONS, TREE LOCATIONS AND OTHER TOPOGRAPHIC INFORMATION SHOWN HEREON HAVE BEEN LOCATED BY SINGLE EDM MEASUREMENTS, WITH THE EXCEPTION OF CONTOUR LINES, THE PURPOSE OF WHICH IS TO SHOW THE GENERAL CONFIGURATION OF THE GROUND AND THE FLOW OF WATER THEREFROM. TOPOGRAPHIC INFORMATION LOCATED BY THIS METHOD CAN NORMALLY BE EXPECTED TO BE ACCURATE WITHIN 0.5 OF A FOOT HORIZONTALLY AND WITHIN 0.2 OF A FOOT VERTICALLY; HOWEVER, THERE IS ALWAYS THE POSSIBILITY OF A FEW ERRORS IN THE FIELD MEASUREMENTS OR IN THE OFFICE PLOTTING OF THE TOPOGRAPHIC INFORMATION UNLESS EACH POINT IS LOCATED AND THE ELEVATION IS DETERMINED FROM 2 DIFFERENT SURVEY CONTROL STATIONS. IT WOULD BE ADVISABLE TO MAKE A PRELIMINARY LOCATION OF ANY PROPOSED IMPROVEMENTS ON THE GROUND BEFORE FINAL PLANS AND CONTRACTS ARE MADE IN ORDER TO VERIFY THE ACCURACY OF THE TOPOGRAPHIC INFORMATION IN RELATION TO THE PROPOSED CONSTRUCTION.
- THE DRAWING SHOWN HEREON DOES NOT NECESSARILY CONTAIN ALL OF THE INFORMATION OBTAINED AND/OR DEVELOPED BY THE SURVEYOR IN HIS FIELD WORK, OFFICE WORK, OR RESEARCH.

VERTICAL DATUM
 CITY OF MERCER ISLAND

BENCHMARK
 SANITARY SEWER MANHOLE AT INTERSECTION OF SE 28TH ST & 62ND AVE SE.

INVERT ELEVATION = 75.4

LEGAL DESCRIPTION
 BLOCKS 12 AND 13, EAST SEATTLE ADDITION PER PLAT RECORDED IN VOLUME 3 PAGES 22 AND 23, RECORDS OF KING COUNTY, WASHINGTON.

TOGETHER WITH VACATED 63RD AVENUE S.E. (VACATED 9-23-59).

SUBJECT TO: EASEMENTS, UTILITIES, RESTRICTIONS, RESERVATIONS, COVENANTS, AGREEMENTS, RIGHTS OF WAY AND ZONING, IF ANY, NOT SHOWN HEREON.

NOTE
 PRELIMINARY DESIGN BY BLUELINE BASED ON SURVEY MAP PROVIDED BY 4 SITE SURVEYING & CONSULTING.

SHEET INDEX

1	CV-01	COVER SHEET
2	EC-01	EXISTING CONDITIONS & DEMO PLAN
3	SP-01	SITE PLAN
4	GP-01	PRELIMINARY GRADING PLAN
5	UP-01	PRELIMINARY UTILITY PLAN
6	RS-01	PRELIMINARY ROAD PLAN & SECTIONS
7	RP-01	PRELIMINARY ROAD PROFILES
8	TR-01	PRELIMINARY TREE RETENTION AND REPLACEMENT PLAN
9	TR-02	TREE TABLES

1 OF 1 COMBINED TOPOGRAPHIC WORKSHEET

SITE DATA

SITE ADDRESS: 2825 W MERCER WAY
 TAX ACCOUNT NUMBER: 2174502425
 ZONING: R-4
 GROSS SITE AREA: 2.88 ACRES (125,315.52 SF)
 GROSS FLOOR AREA: 40%
 NUMBER OF LOTS PROPOSED: 14
 PROPOSED USE: SINGLE FAMILY
 MINIMUM LOT SIZE ALLOWED: 8,400 SF
 SETBACKS: FRONT 20' (D), REAR 25' (D), SIDE 5' (S) (BUT 2 SIDE YARDS MUST EQUATE 15')
 14
 40% MAX (LOT SLOPE LESS THAN 15%)
 30' MAX ABOVE ABE

LOT COVERAGE:
 BUILDING HEIGHT:

UNDERGROUND UTILITY NOTE

UNDERGROUND UTILITIES ARE SHOWN IN THE APPROXIMATE LOCATION. THERE IS NO GUARANTEE THAT ALL UTILITY LINES ARE SHOWN, OR THAT THE LOCATION, SIZE AND MATERIAL IS ACCURATE. THE CONTRACTOR SHALL UNCOVER ALL INDICATED PIPING WHERE CROSSING, INTERFERENCES, OR CONNECTIONS OCCUR PRIOR TO TRENCHING OR EXCAVATION FOR ANY PIPE OR STRUCTURES, TO DETERMINE ACTUAL LOCATIONS, SIZE AND MATERIAL. THE CONTRACTOR SHALL MAKE THE APPROPRIATE PROVISION FOR PROTECTION OF SAID FACILITIES. THE CONTRACTOR SHALL NOTIFY ONE CALL AT 8-1-1 (WASHINGTON11.COM) AND ARRANGE FOR FIELD LOCATION OF EXISTING FACILITIES BEFORE CONSTRUCTION.

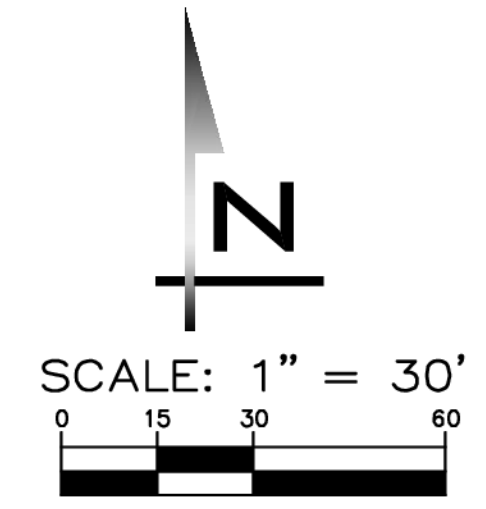
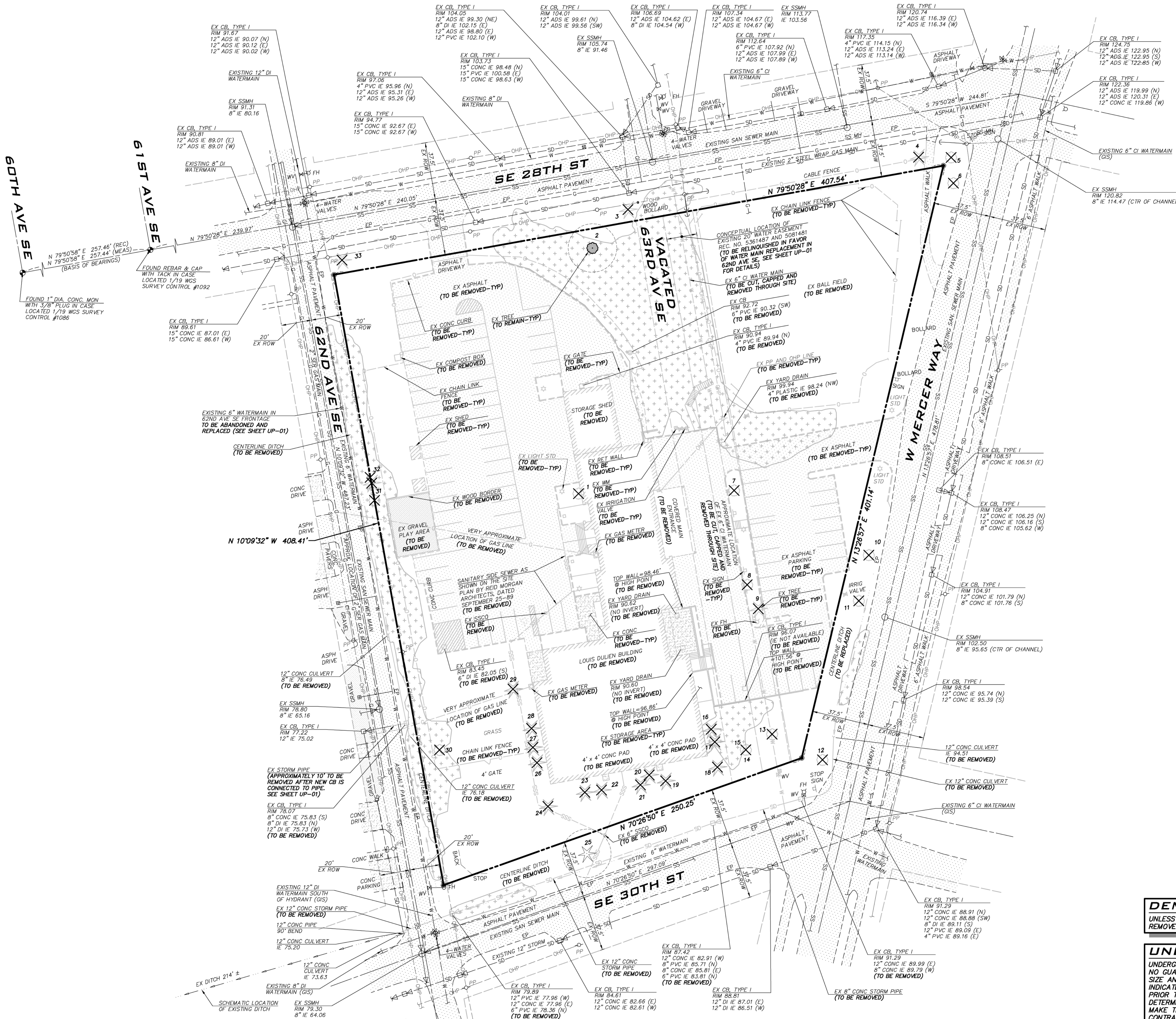

BLUELINE

25 CENTRAL WAY, SUITE 400,
KIRKLAND, WA 98033
P: 425.216.4051 F: 425.216.4052
WWW.THEBLUELINEGROUP.COM

SCALE: AS NOTED
PROJECT MANAGER:
BRETT K PUDISTIS, PE
PROJECT ENGINEER:
LYNDEY FEDAK, PE
DESIGNER:
AARON C LANCE
ISSUE DATE:
2/16/2023

NO	DATE	BY	REVISIONS	
			REVISED PER CITY COMMENTS	REVISED PER CITY COMMENTS
1	2/22/23	MWK		
2	10/22/22	MWK		
3	2/16/23	MWK		

EXISTING CONDITIONS & DEMO PLAN
2825 W MERCER WAY
PRELIMINARY PLAN
PARCEL #2174502425
CITY OF MERCER ISLAND WASHINGTON

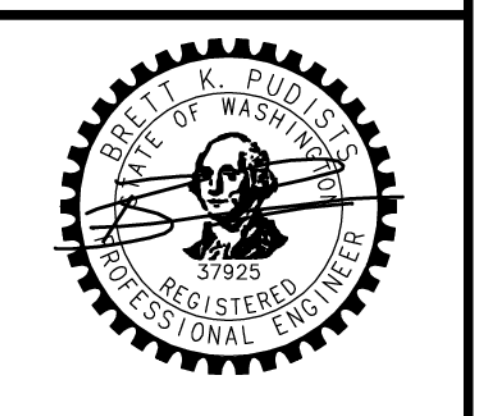

2/16/23
JOB NUMBER:
13-118
SHEET NAME:
EC-01
SHT **2** OF **9**

DEMO NOTE
UNLESS OTHERWISE NOTED, EXISTING ONSITE BUILDINGS AND HARDSCAPE TO BE REMOVED. SEPARATE DEMO PERMIT IS REQUIRED.

UNDERGROUND UTILITY NOTE
UNDERGROUND UTILITIES ARE SHOWN IN THE APPROXIMATE LOCATION. THERE IS NO GUARANTEE THAT ALL UTILITY LINES ARE SHOWN, OR THAT THE LOCATION, SIZE AND MATERIAL IS ACCURATE. THE CONTRACTOR SHALL UNCOVER ALL INDICATED PIPING WHERE CROSSING, INTERFERENCES, OR CONNECTIONS OCCUR PRIOR TO TRENCHING OR EXCAVATION FOR ANY PIPE OR STRUCTURES, TO DETERMINE ACTUAL LOCATIONS, SIZE AND MATERIAL. THE CONTRACTOR SHALL MAKE THE APPROPRIATE PROVISION FOR PROTECTION OF SAID FACILITIES. THE CONTRACTOR SHALL NOTIFY ONE CALL AT 8-1-1 (WASHINGTON11.COM) AND ARRANGE FOR FIELD LOCATION OF EXISTING FACILITIES BEFORE CONSTRUCTION.

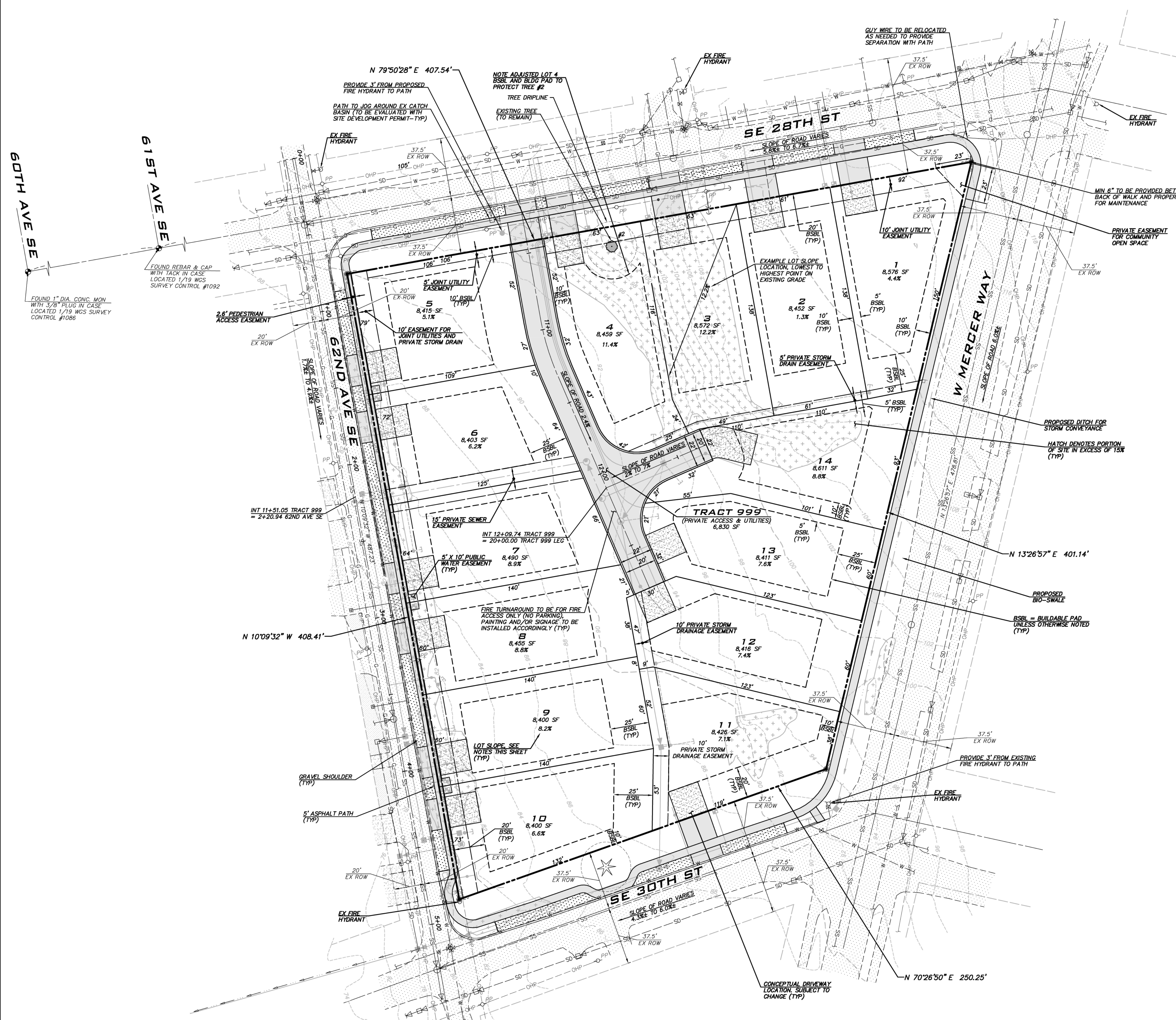
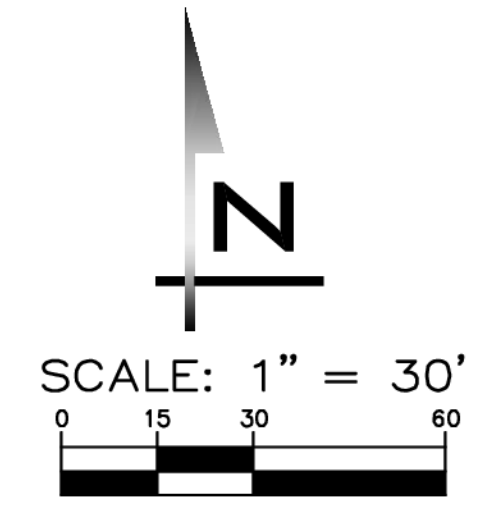

ADA COMPLIANCE
 ASPHALT PATHS TO BE ADA COMPLIANT. ADDITIONAL DETAIL TO BE PROVIDED WITH SITE DEVELOPMENT PERMIT.

LOT COVERAGE TABLE

LOT NO.	LOT AREA (SF)	LOT COVERAGE (SF)*	LANDSCAPING AREA (SF)**	PORTION OF LANDSCAPING AREA THAT CAN BE HARDSCAPE (SF)**
1	8,576	3,430	5,146	772
2	8,452	3,381	5,071	761
3	8,572	3,429	5,143	771
4	8,459	3,384	5,075	761
5	8,415	3,366	5,049	757
6	8,403	3,361	5,042	756
7	8,490	3,396	5,094	764
8	8,455	3,382	5,073	761
9	8,400	3,360	5,040	756
10	8,400	3,360	5,040	756
11	8,426	3,370	5,056	758
12	8,416	3,366	5,050	757
13	8,411	3,364	5,047	757
14	8,611	3,444	5,167	775

*LOT COVERAGE (40% OF THE LOT AREA) AND LANDSCAPING AREA (60% OF THE LOT AREA) ARE BASED ON THE EXISTING SLOPE
 **REQUIRED LANDSCAPING AREA SHALL CONSIST OF SOFTSCAPE IMPROVEMENTS, EXCEPT WHERE USED FOR HARDSCAPE IMPROVEMENTS. 9% OF THE LOT AREA MAY CONSIST OF

FIRE SPRINKLERS
 NEW SINGLE FAMILY RESIDENCES REQUIRE A MINIMUM OF 13D SPRINKLER SYSTEM.

LOT SLOPES

DENOTES AREAS OF SLOPE ≥ 15%

X.X% SLOPE OF LOT = ((HIGHEST LOT ELEVATION - LOWEST LOT ELEVATION) / HORIZONTAL DISTANCE) X 100

CRITICAL AREAS NOTE
 NO CRITICAL AREAS WERE IDENTIFIED ON SITE.

NEAREST FIRE HYDRANT
 EXISTING FIRE HYDRANTS ARE LOCATED NEAR EACH STREET INTERSECTION AND HAVE BEEN LABELED FOR CONVENIENCE.

BUILDING HEIGHTS

- PROPOSED BUILDINGS WILL BE DESIGNED IN THE FUTURE AS PART OF THE BUILDING PERMIT PROCESS.
- AVERAGE BUILDING ELEVATION GRADE POINTS TO BE DETERMINED BASED ON PROPOSED BUILDINGS BY OTHERS.

NOTES

- SEE LEGEND ON SHEET CV-01.
- REFER TO SHEET EC-01 FOR EXISTING FEATURES THAT WILL BE REMOVED.
- REFER TO SHEET GP-01 FOR PRELIMINARY GRADING PLAN.
- REFER TO SHEET UP-01 FOR PRELIMINARY UTILITY PLAN.
- SEE SHEET RS-01 FOR ROAD SLOPES AND CROSS SECTIONS.
- SEE SHEET TR-01 FOR TREE NUMBERS AND RETENTION SUMMARY.
- DIRECT VEHICULAR ACCESS TO W MERCER WAY IS PROHIBITED.

UNDERGROUND UTILITY NOTE
 UNDERGROUND UTILITIES ARE SHOWN IN THE APPROXIMATE LOCATION. THERE IS NO GUARANTEE THAT ALL UTILITY LINES ARE SHOWN, OR THAT THE LOCATION, SIZE AND MATERIAL IS ACCURATE. THE CONTRACTOR SHALL UNCOVER ALL INDICATED PIPING WHERE CROSSING, INTERFERENCES, OR CONNECTIONS OCCUR PRIOR TO TRENCHING OR EXCAVATION FOR ANY PIPE OR STRUCTURES, TO DETERMINE ACTUAL LOCATIONS, SIZE AND MATERIAL. THE CONTRACTOR SHALL MAKE THE APPROPRIATE PROVISION FOR PROTECTION OF SAID FACILITIES. THE CONTRACTOR SHALL NOTIFY ONE CALL AT 8-1-1 (WASHINGTON11.COM) AND ARRANGE FOR FIELD LOCATION OF EXISTING FACILITIES BEFORE CONSTRUCTION.

REVISIONS

NO	DATE	BY	REASON
1	1/24/23	AWK	REVISED PER CITY COMMENTS
2	10/12/22	AWK	REVISED PER CITY COMMENTS
3	2/16/23	AWK	REVISED PER CITY COMMENTS

SITE PLAN
2825 W MERCER WAY
PRELIMINARY PLAN
PARCEL #2174502425
CITY OF MERCER ISLAND WASHINGTON

2/16/23
 JOB NUMBER:
13-118
 SHEET NAME:
SP-01
 SHT **3** OF **9**

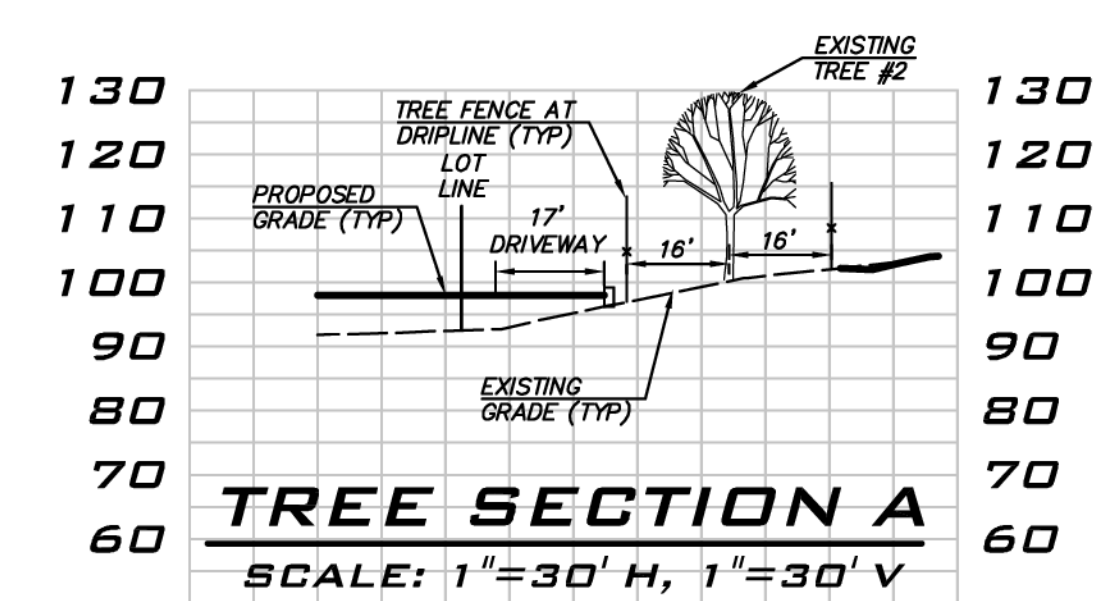
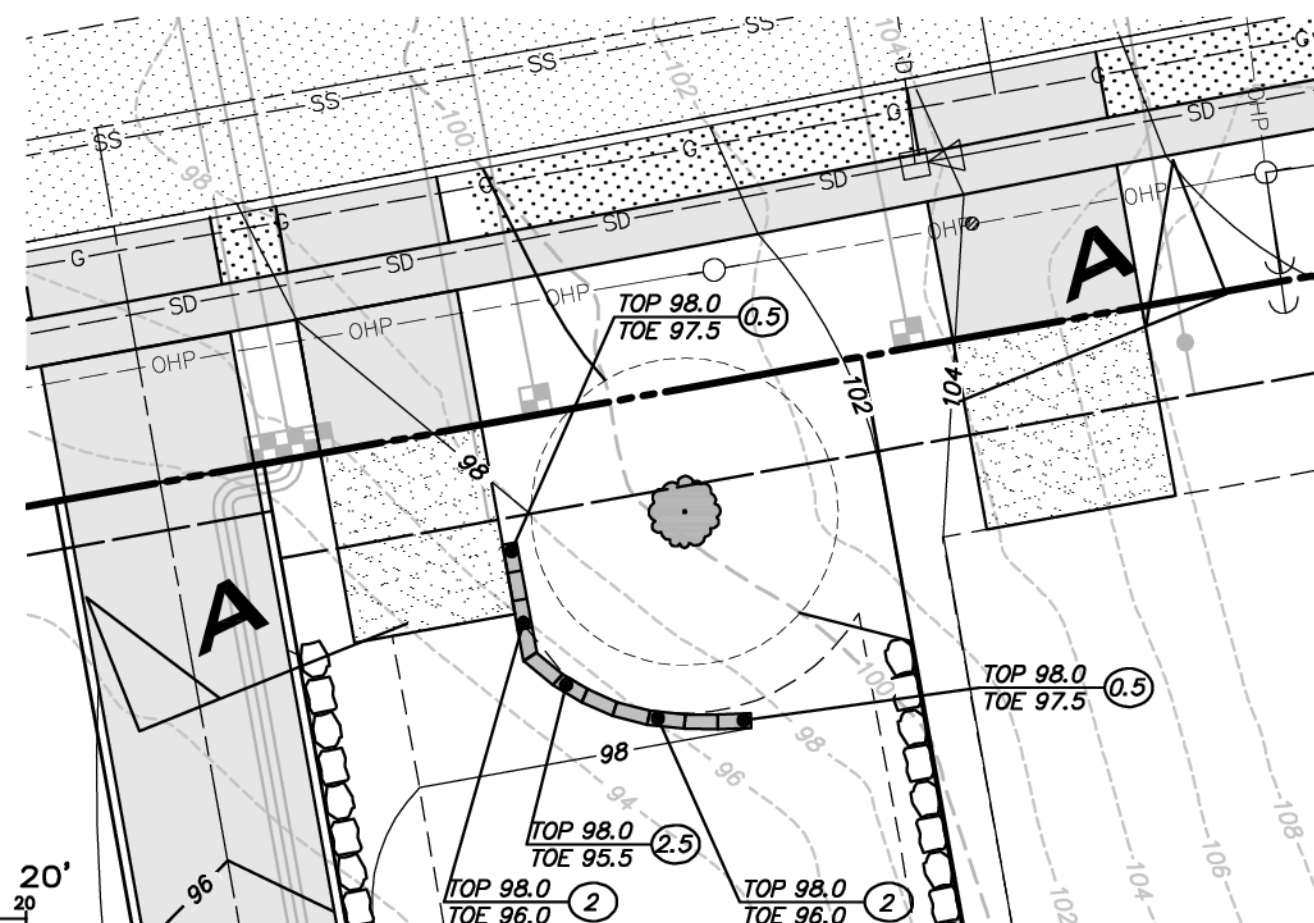
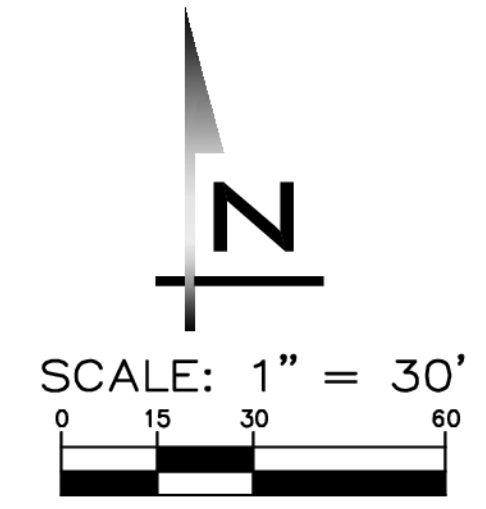
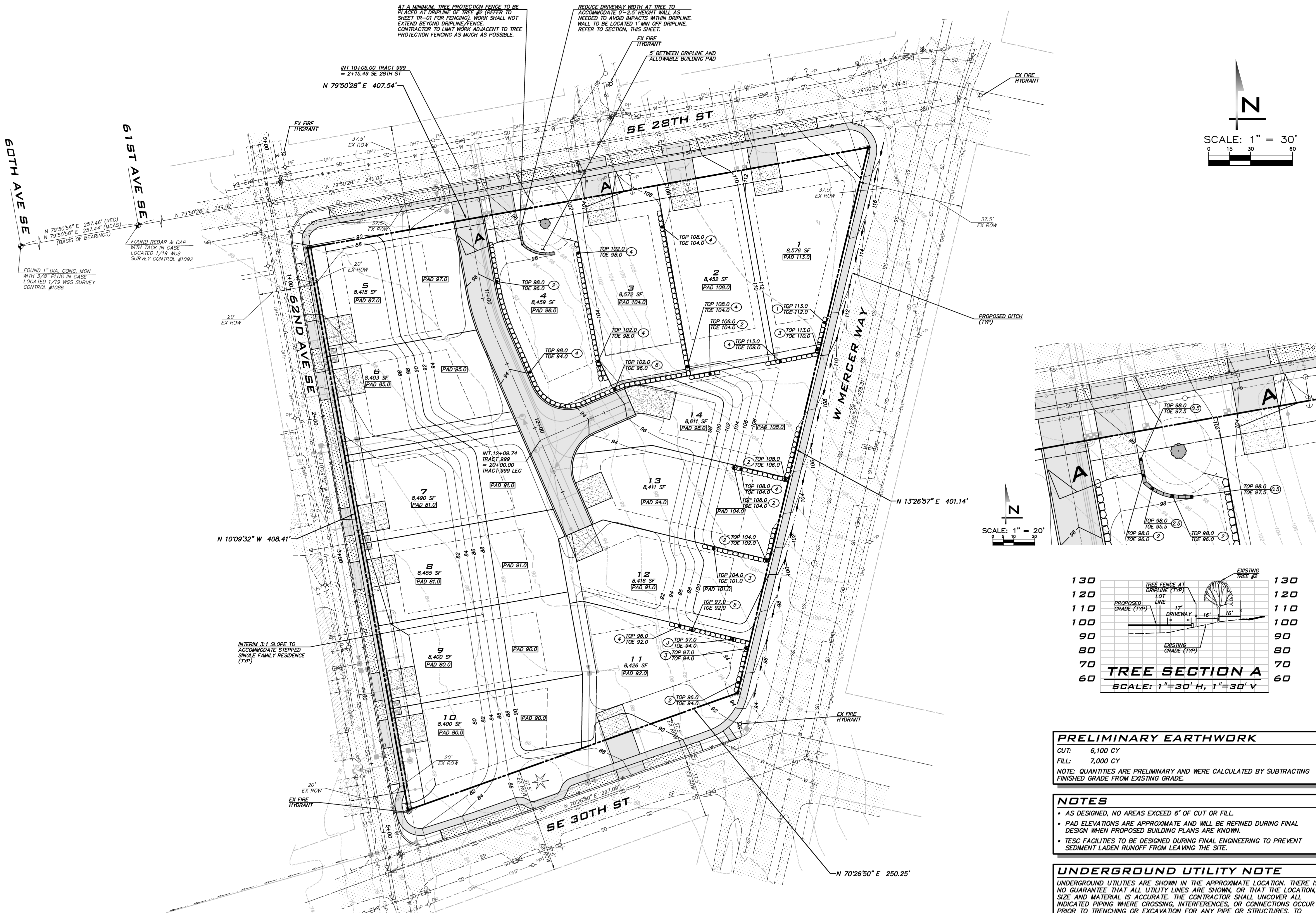

PRELIMINARY EARTHWORK
 CUT: 6,100 CY
 FILL: 7,000 CY
 NOTE: QUANTITIES ARE PRELIMINARY AND WERE CALCULATED BY SUBTRACTING FINISHED GRADE FROM EXISTING GRADE.

NOTES

- AS DESIGNED, NO AREAS EXCEED 6' OF CUT OR FILL.
- PAD ELEVATIONS ARE APPROXIMATE AND WILL BE REFINED DURING FINAL DESIGN WHEN PROPOSED BUILDING PLANS ARE KNOWN.
- TESC FACILITIES TO BE DESIGNED DURING FINAL ENGINEERING TO PREVENT SEDIMENT LADEN RUNOFF FROM LEAVING THE SITE.

UNDERGROUND UTILITY NOTE
 UNDERGROUND UTILITIES ARE SHOWN IN THE APPROXIMATE LOCATION. THERE IS NO GUARANTEE THAT ALL UTILITY LINES ARE SHOWN, OR THAT THE LOCATION, SIZE AND MATERIAL IS ACCURATE. THE CONTRACTOR SHALL UNCOVER ALL INDICATED PIPING WHERE CROSSING, INTERFERENCES, OR CONNECTIONS OCCUR PRIOR TO TRENCHING OR EXCAVATION FOR ANY PIPE OR STRUCTURES, TO DETERMINE ACTUAL LOCATIONS, SIZE AND MATERIAL. THE CONTRACTOR SHALL MAKE THE APPROPRIATE PROVISION FOR PROTECTION OF SAID FACILITIES. THE CONTRACTOR SHALL NOTIFY ONE CALL AT 8-1-1 (WASHINGTON11.COM) AND ARRANGE FOR FIELD LOCATION OF EXISTING FACILITIES BEFORE CONSTRUCTION.

BLUeline
 25 CENTRAL WAY, SUITE 400, KIRKLAND, WA 98033
 P: 425.216.4051 F: 425.216.4052 WWW.THEBLUelineGROUP.COM

SCALE: AS NOTED
 PROJECT MANAGER: BRETT K PULISTIS, PE
 PROJECT ENGINEER: LYNSEY FEDAK, PE
 DESIGNER: AARON C LANCE
 ISSUE DATE: 2/16/2023

NO	DATE	BY	REVISIONS
1	2/16/23	MWK	REVISION PER CITY COMMENTS
2	2/16/23	MWK	REVISION PER CITY COMMENTS
3	2/16/23	MWK	REVISION PER CITY COMMENTS

PRELIMINARY GRADING PLAN
2825 W MERCER WAY
PRELIMINARY PLAN
 PARCEL #2174502425
 CITY OF MERCER ISLAND WASHINGTON

2/16/23
 JOB NUMBER: **13-118**
 SHEET NAME: **GP-01**
 SHT **4** OF **9**

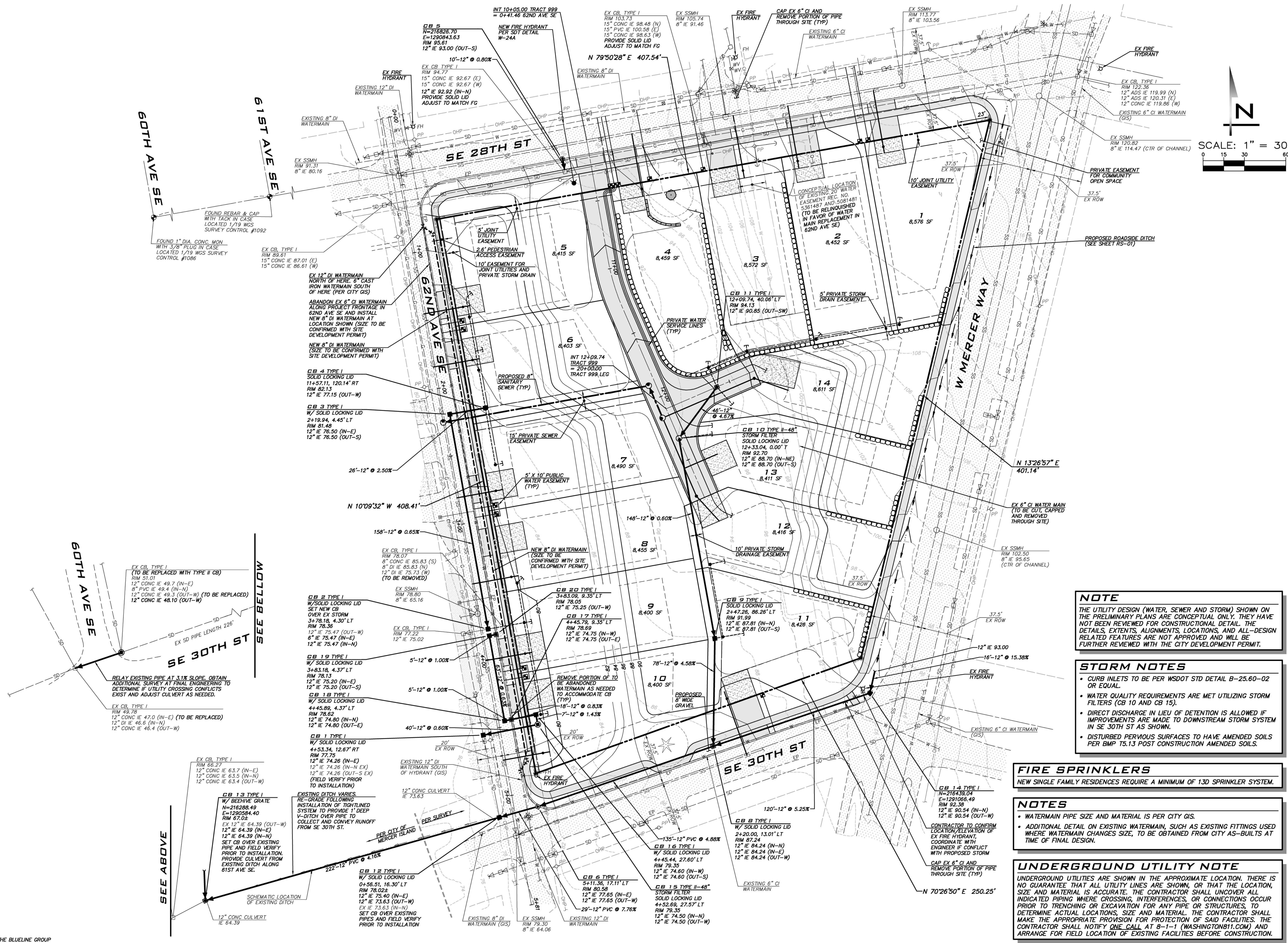
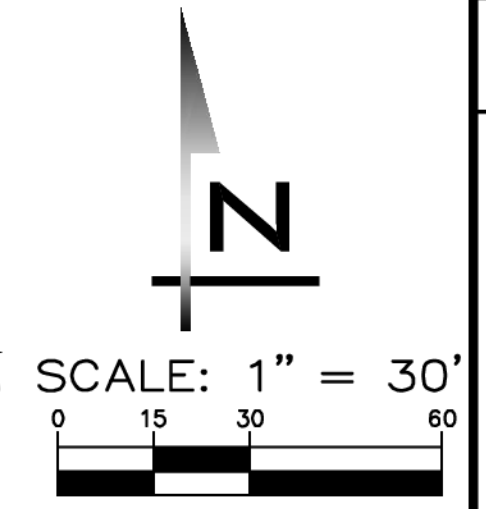

NOTE
 THE UTILITY DESIGN (WATER, SEWER AND STORM) SHOWN ON THE PRELIMINARY PLANS ARE CONCEPTUAL ONLY. THEY HAVE NOT BEEN REVIEWED FOR CONSTRUCTIONAL DETAIL. THE DETAILS, EXTENTS, ALIGNMENTS, LOCATIONS, AND ALL-DESIGN RELATED FEATURES ARE NOT APPROVED AND WILL BE FURTHER REVIEWED WITH THE CITY DEVELOPMENT PERMIT.

STORM NOTES

- CURB INLETS TO BE PER WSDOT STD DETAIL B-25.60-02 OR EQUAL.
- WATER QUALITY REQUIREMENTS ARE MET UTILIZING STORM FILTERS (CB 10 AND CB 15).
- DIRECT DISCHARGE IN LIEU OF DETENTION IS ALLOWED IF IMPROVEMENTS ARE MADE TO DOWNSTREAM STORM SYSTEM IN SE 30TH ST AS SHOWN.
- DISTURBED PVIOUS SURFACES TO HAVE AMENDED SOILS PER BMP T5.13 POST CONSTRUCTION AMENDED SOILS.

FIRE SPRINKLERS
 NEW SINGLE FAMILY RESIDENCES REQUIRE A MINIMUM OF 1.3D SPRINKLER SYSTEM.

NOTES

- WATERMAIN PIPE SIZE AND MATERIAL IS PER CITY GIS.
- ADDITIONAL DETAIL ON EXISTING WATERMAIN, SUCH AS EXISTING FITTINGS USED WHERE WATERMAIN CHANGES SIZE, TO BE OBTAINED FROM CITY AS-BUILTS AT TIME OF FINAL DESIGN.

UNDERGROUND UTILITY NOTE
 UNDERGROUND UTILITIES ARE SHOWN IN THE APPROXIMATE LOCATION. THERE IS NO GUARANTEE THAT ALL UTILITY LINES ARE SHOWN, OR THAT THE LOCATION, SIZE AND MATERIAL IS ACCURATE. THE CONTRACTOR SHALL UNCOVER ALL INDICATED PIPING WHERE CROSSING, INTERFERENCES, OR CONNECTIONS OCCUR PRIOR TO TRENCHING OR EXCAVATION FOR ANY PIPE OR STRUCTURES, TO DETERMINE ACTUAL LOCATIONS, SIZE AND MATERIAL. THE CONTRACTOR SHALL MAKE THE APPROPRIATE PROVISION FOR PROTECTION OF SAID FACILITIES. THE CONTRACTOR SHALL NOTIFY ONE CALL AT 8-1-1 (WASHINGTON11.COM) AND ARRANGE FOR FIELD LOCATION OF EXISTING FACILITIES BEFORE CONSTRUCTION.

NO	DATE	BY	REVISIONS
1	2/16/23	MWK	ISSUED PER CITY COMMENTS
2	10/12/22	MWK	REVISED PER CITY COMMENTS
3	2/16/23	MWK	REVISED PER CITY COMMENTS

PRELIMINARY UTILITY PLAN
2825 W MERCER WAY
PRELIMINARY PLAN
PARCEL #2174502425
CITY OF MERCER ISLAND WASHINGTON

2/16/23
 JOB NUMBER:
13-118
 SHEET NAME:
UP-01
 SHT **5** OF **9**

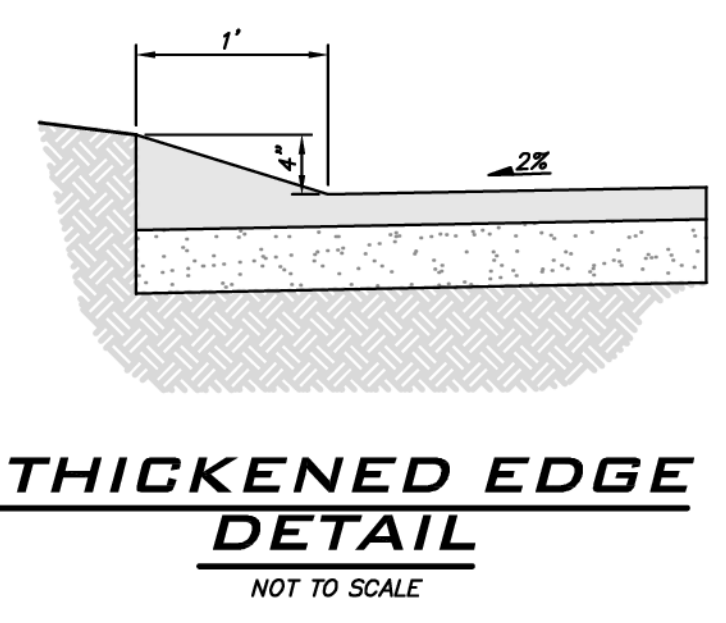
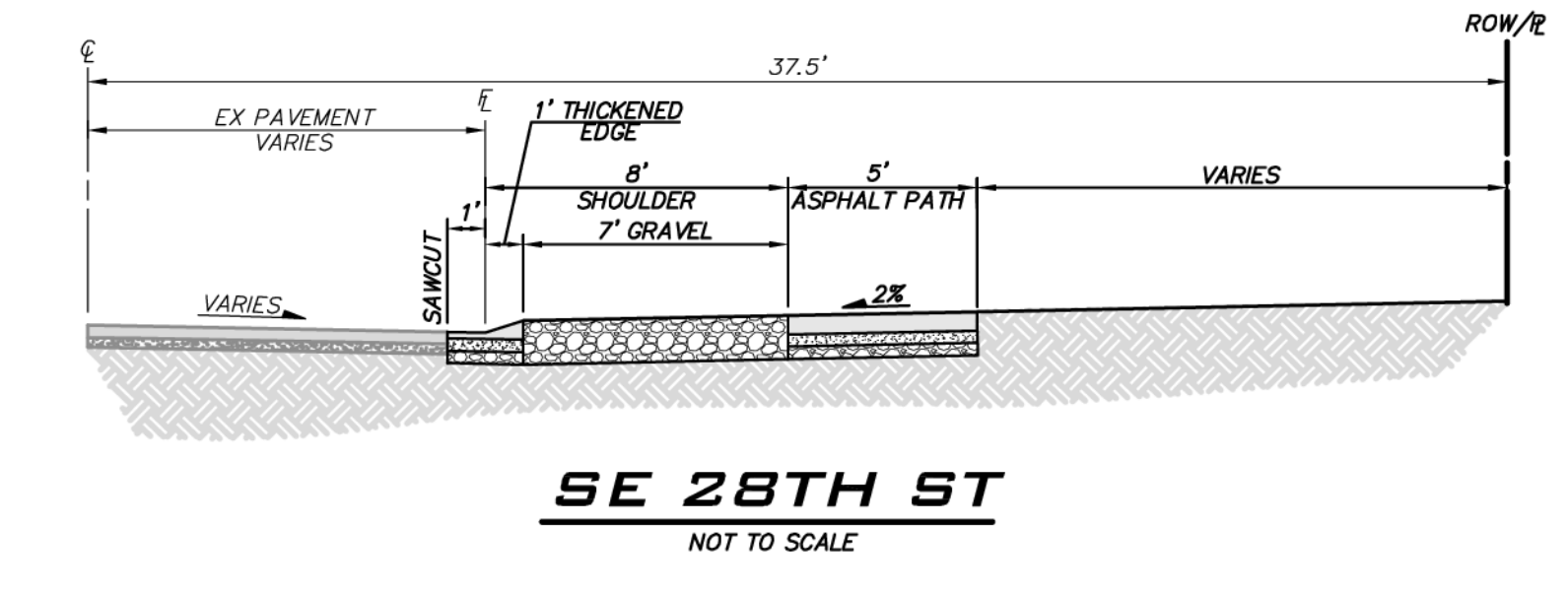
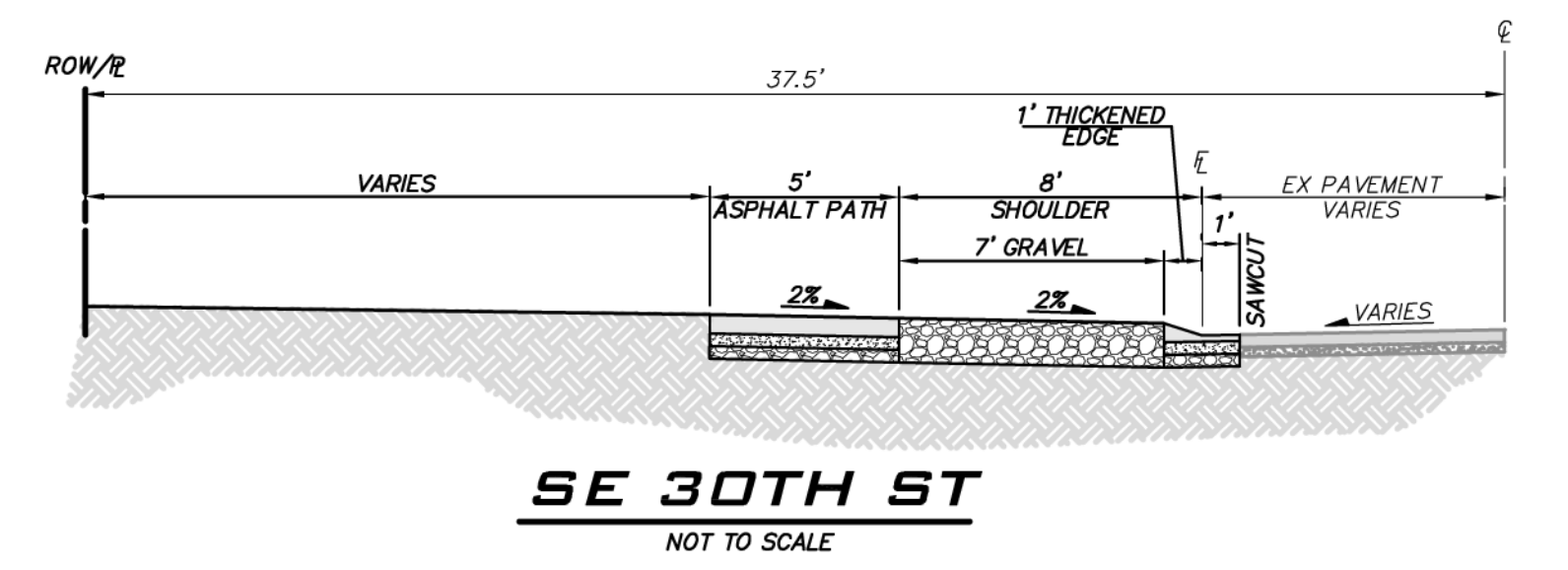
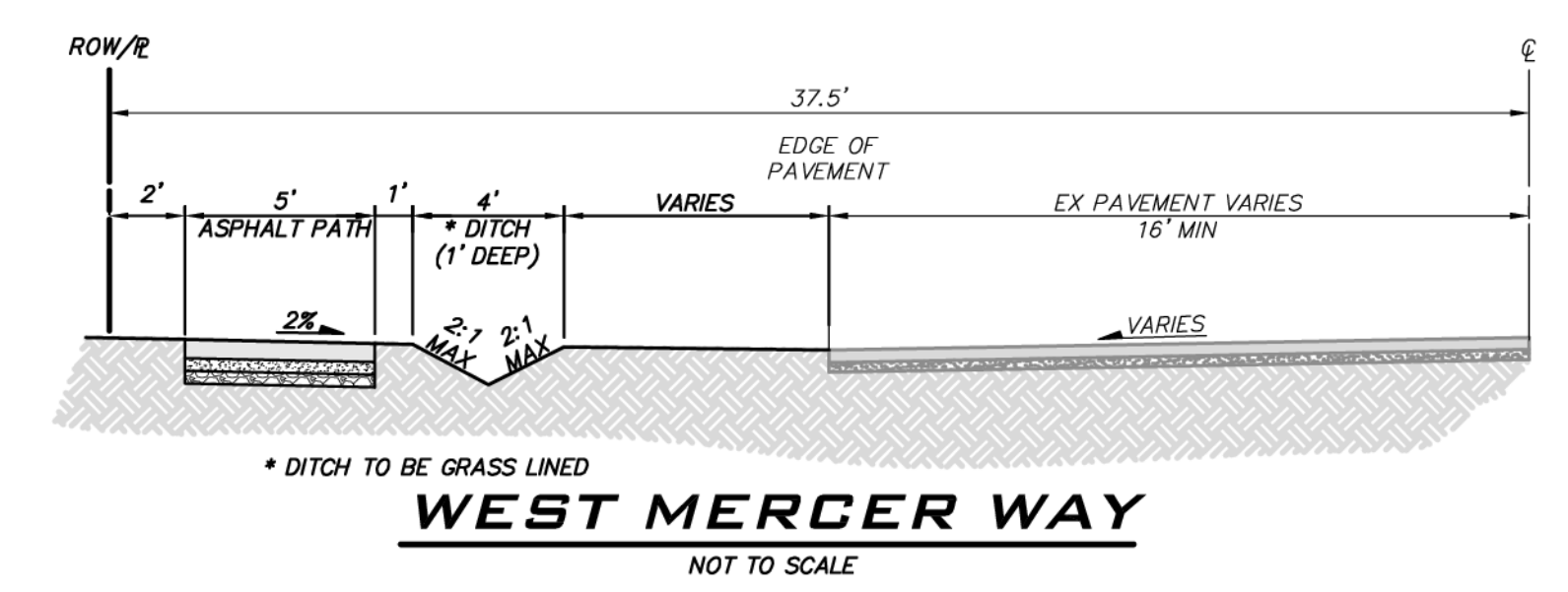
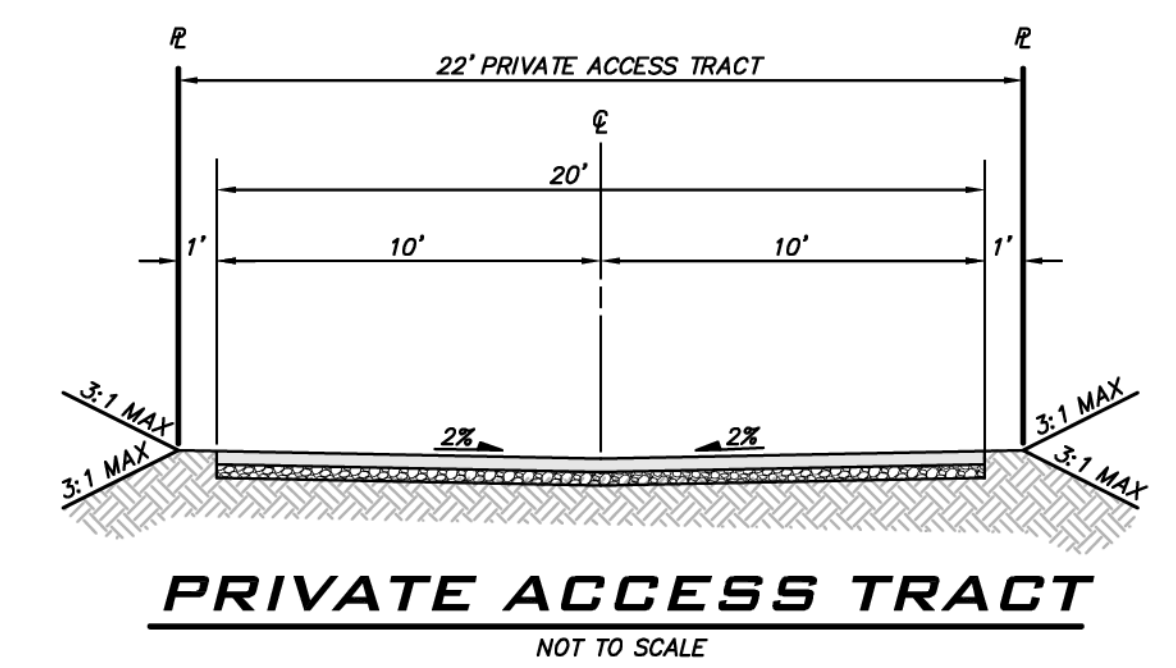
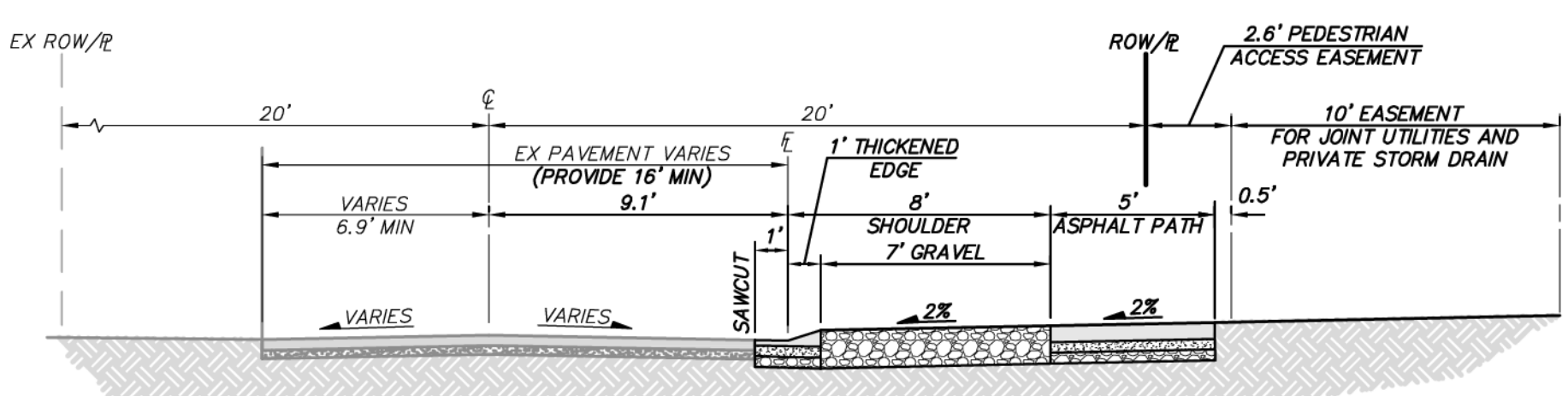
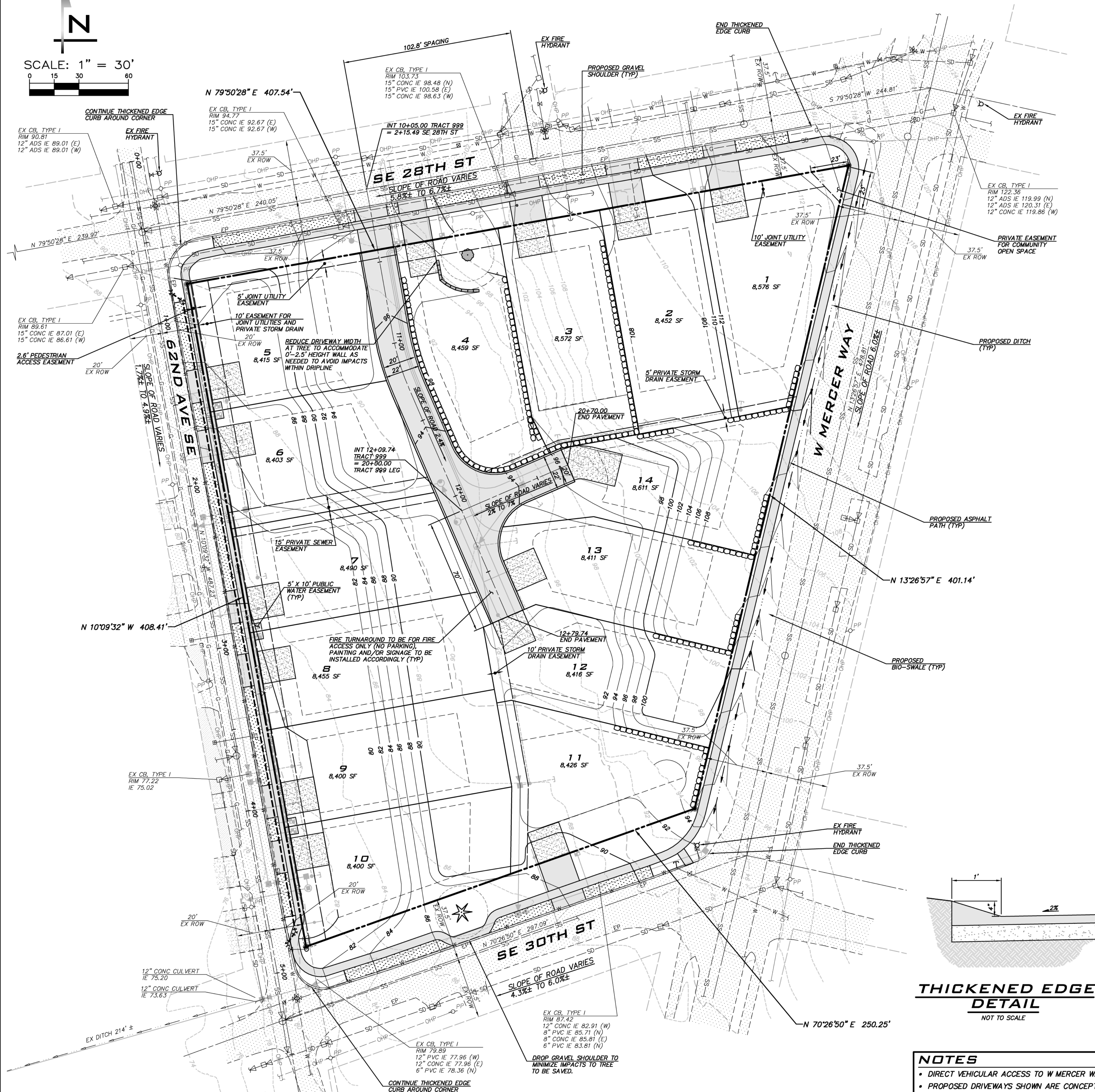
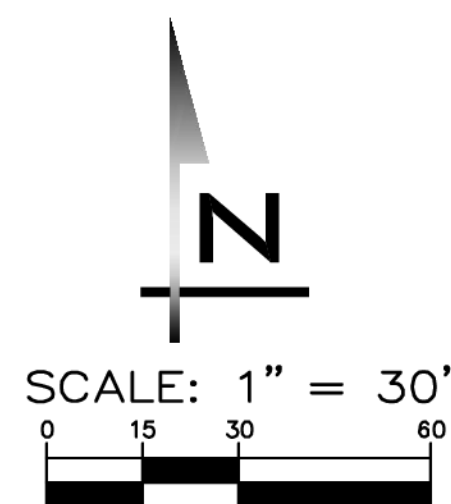

- NOTES**
- DIRECT VEHICULAR ACCESS TO W MERCER WAY IS PROHIBITED.
 - PROPOSED DRIVEWAYS SHOWN ARE CONCEPTUAL AND SUBJECT TO CHANGE.
 - MAX LOT SERVED BY PRIVATE ACES TRACT IS THREE.

UNDERGROUND UTILITY NOTE

UNDERGROUND UTILITIES ARE SHOWN IN THE APPROXIMATE LOCATION. THERE IS NO GUARANTEE THAT ALL UTILITY LINES ARE SHOWN, OR THAT THE LOCATION, SIZE AND MATERIAL IS ACCURATE. THE CONTRACTOR SHALL UNCOVER ALL INDICATED PIPING WHERE CROSSING, INTERFERENCES, OR CONNECTIONS OCCUR PRIOR TO TRENCHING OR EXCAVATION FOR ANY PIPE OR STRUCTURES, TO DETERMINE ACTUAL LOCATIONS, SIZE AND MATERIAL. THE CONTRACTOR SHALL MAKE THE APPROPRIATE PROVISION FOR PROTECTION OF SAID FACILITIES. THE CONTRACTOR SHALL NOTIFY ONE CALL AT 8-1-1 (WASHINGTON1.COM) AND ARRANGE FOR FIELD LOCATION OF EXISTING FACILITIES BEFORE CONSTRUCTION.

BLUeline

25 CENTRAL WAY, SUITE 400,
KIRKLAND, WA 98033
P: 425.216.4051 F: 425.216.4052
WWW.THEBLUelineGROUP.COM

SCALE: AS NOTED
PROJECT MANAGER: BRETT K. PUDISTIS, PE
PROJECT ENGINEER: LYNSEY FEDAK, PE
DESIGNER: AARON C LANCE
ISSUE DATE: 2/16/2023

NO	DATE	BY	REVISIONS
1	2/16/23	MWK	REVISION PER CITY COMMENTS
2	10/12/22	MWK	REVISION PER CITY COMMENTS
3	2/16/23	MWK	REVISION PER CITY COMMENTS

PRELIMINARY ROAD PLAN & SECTIONS
2825 W MERCER WAY
PRELIMINARY PLAN
PARCEL #2174502425
CITY OF MERCER ISLAND WASHINGTON

2/16/23
JOB NUMBER: 13-118
SHEET NAME: RS-01
SHT 6 OF 9

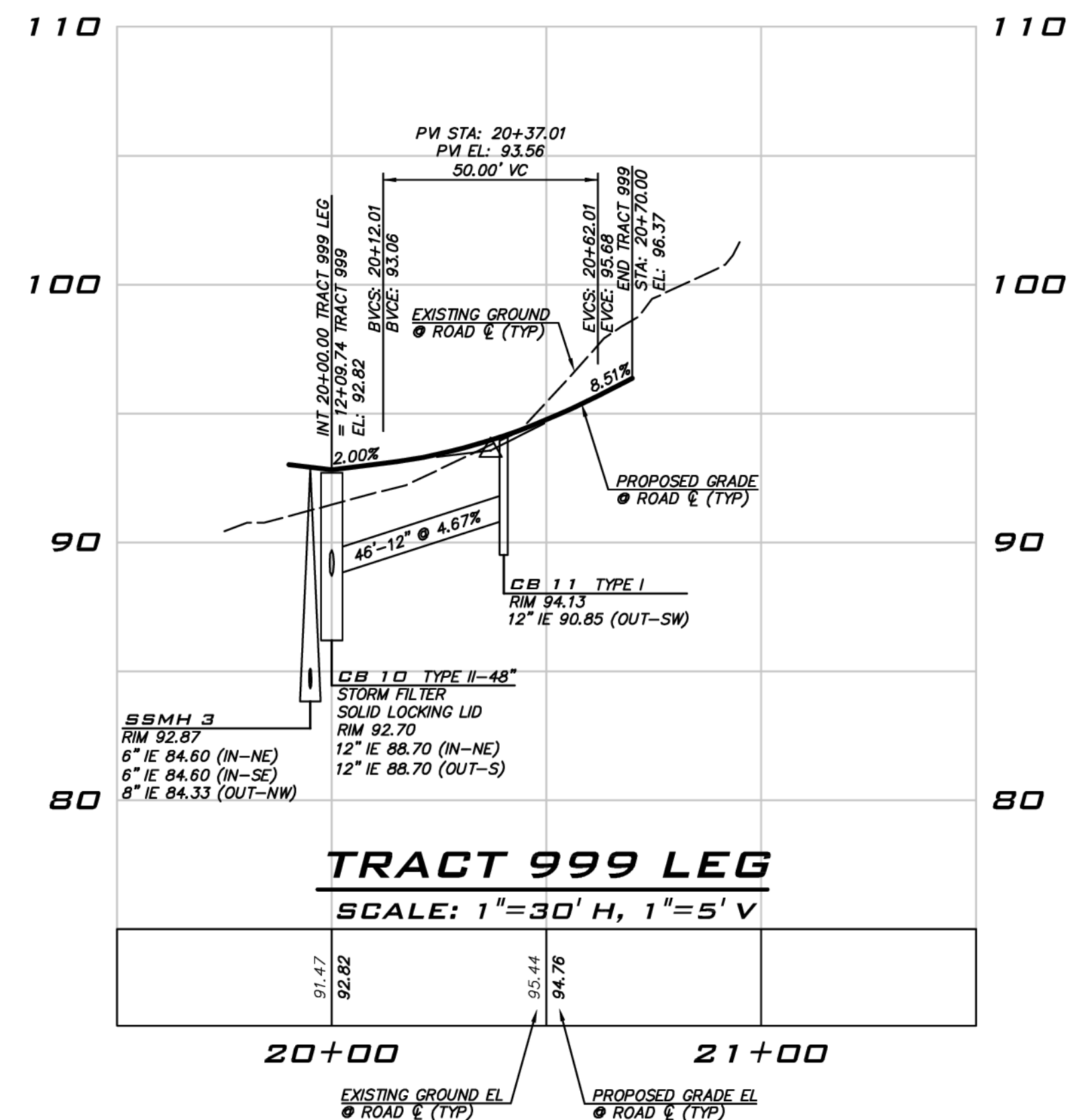
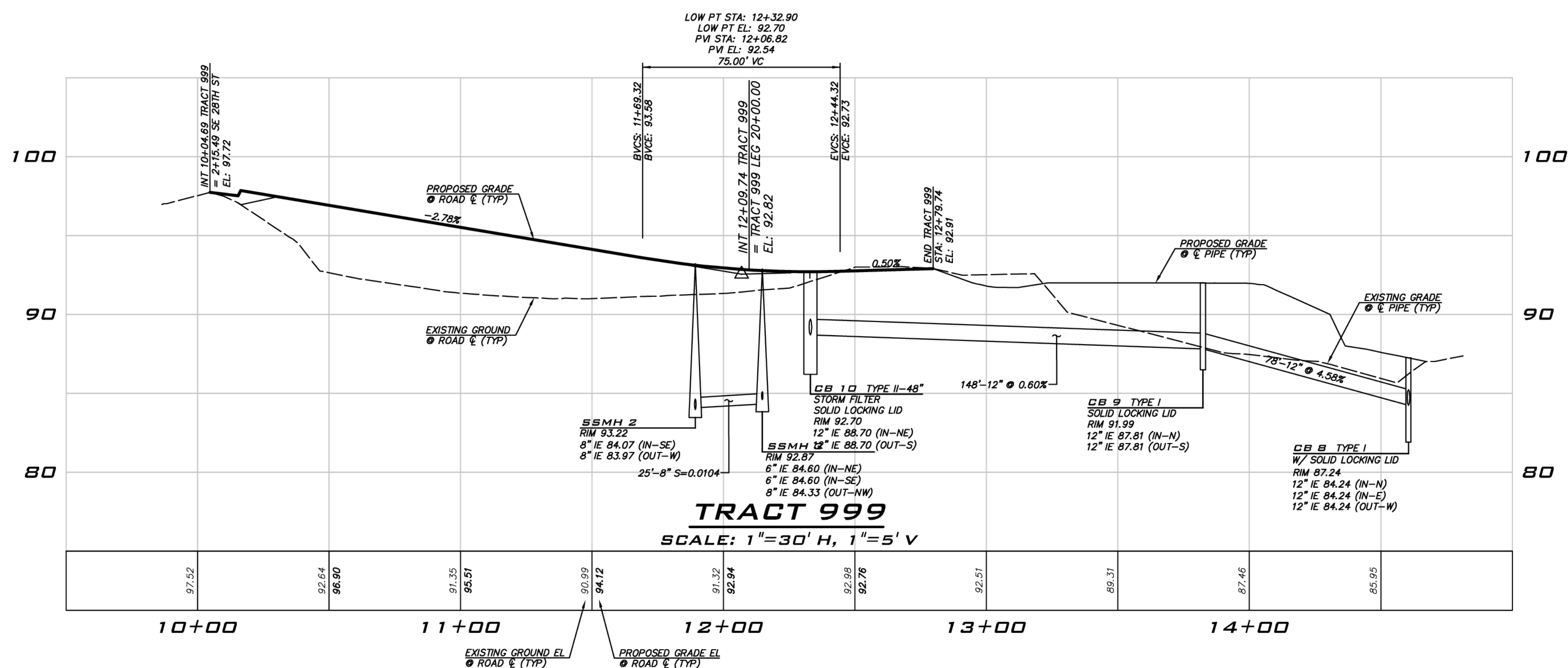
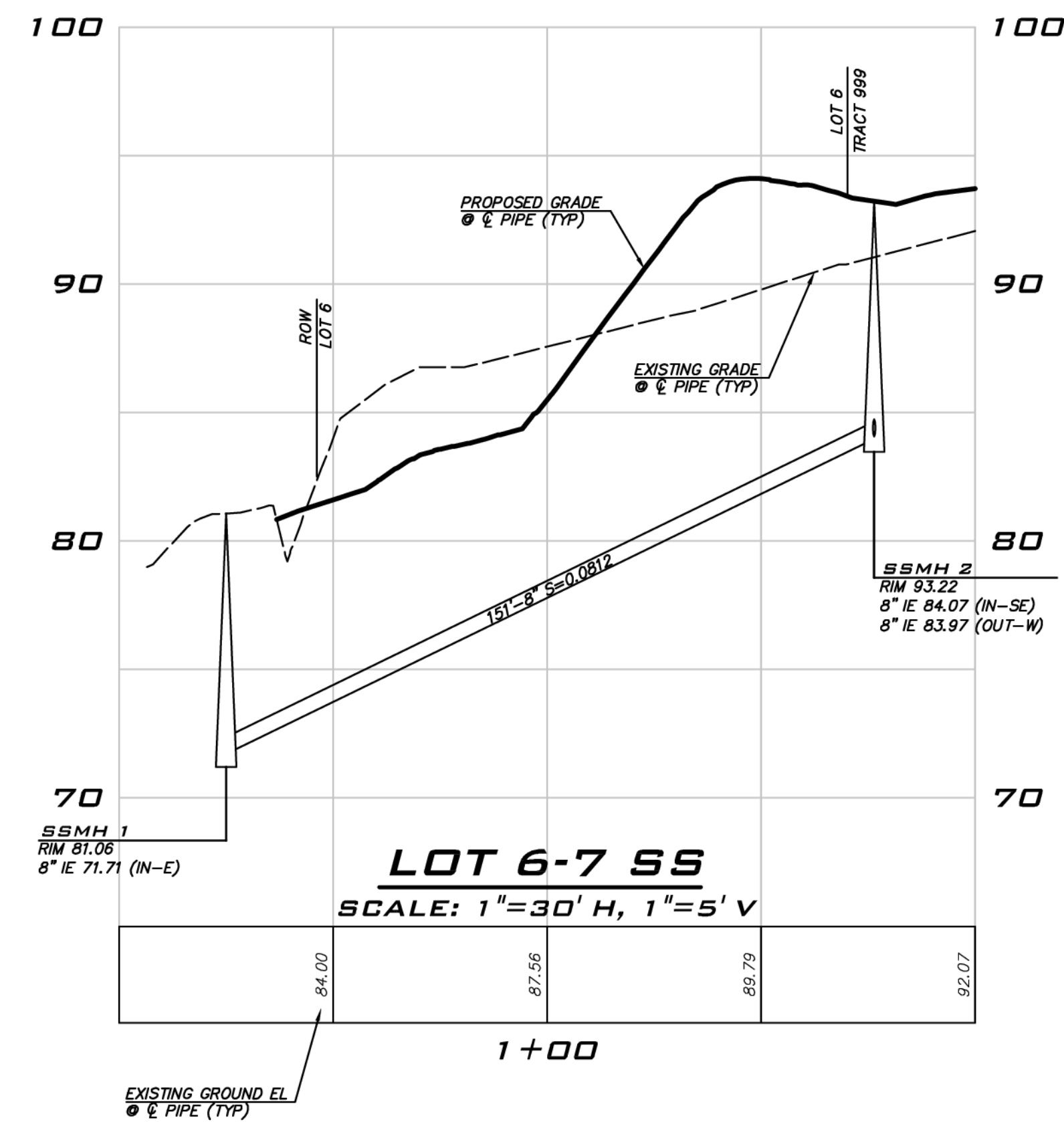
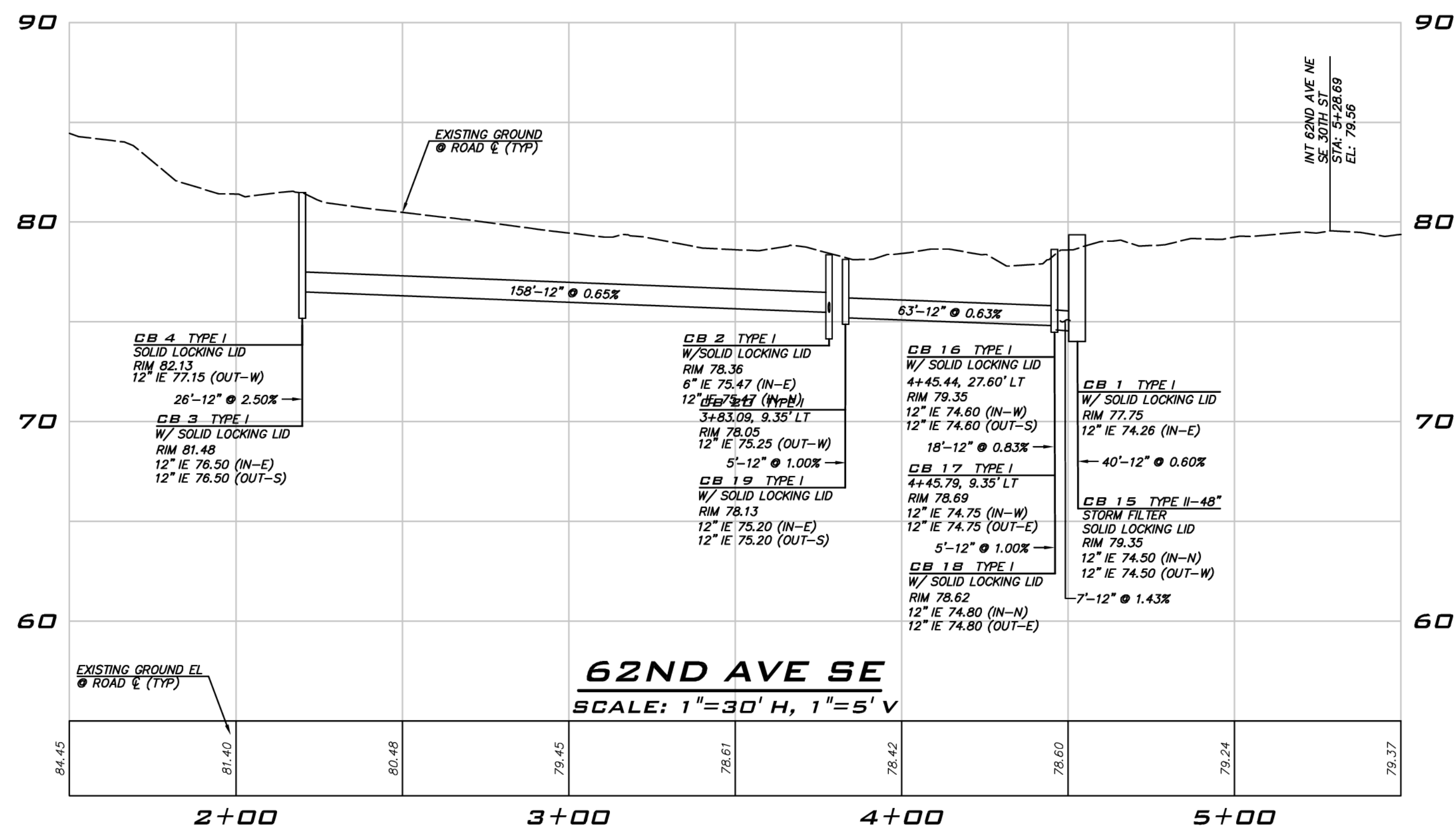

NOTE
NO DIRECT VEHICULAR ACCESS TO W MERCER WAY.

UNDERGROUND UTILITY NOTE
UNDERGROUND UTILITIES ARE SHOWN IN THE APPROXIMATE LOCATION. THERE IS NO GUARANTEE THAT ALL UTILITY LINES ARE SHOWN, OR THAT THE LOCATION, SIZE AND MATERIAL IS ACCURATE. THE CONTRACTOR SHALL UNCOVER ALL INDICATED PIPING WHERE CROSSING, INTERFERENCES, OR CONNECTIONS OCCUR PRIOR TO TRENCHING OR EXCAVATION FOR ANY PIPE OR STRUCTURES, TO DETERMINE ACTUAL LOCATIONS, SIZE AND MATERIAL. THE CONTRACTOR SHALL MAKE THE APPROPRIATE PROVISION FOR PROTECTION OF SAID FACILITIES. THE CONTRACTOR SHALL NOTIFY ONE CALL AT 8-1-1 (WASHINGTON11.COM) AND ARRANGE FOR FIELD LOCATION OF EXISTING FACILITIES BEFORE CONSTRUCTION.

BLUELINE
25 CENTRAL WAY, SUITE 400, KIRKLAND, WA 98033
P: 425.216.4051 F: 425.216.4052 WWW.THEBLUELINEGROUP.COM

SCALE: AS NOTED
PROJECT MANAGER: BRETT K PUDISTIS, PE
PROJECT ENGINEER: LYNDESE FEDAK, PE
DESIGNER: AARON C LANCE
ISSUE DATE: 2/16/2023

NO	DATE	BY	REVISIONS
1	2/22/21	MWK	REVISION PER CITY COMMENTS
2	10/22/22	MWK	REVISION PER CITY COMMENTS
3	2/16/23	MWK	REVISION PER CITY COMMENTS

PRELIMINARY ROAD PROFILES
2825 W MERCER WAY
PRELIMINARY PLAT
PARCEL #2174502425
CITY OF MERCER ISLAND WASHINGTON

BRETT K. PUDISTIS
REGISTERED PROFESSIONAL ENGINEER
2/16/23
JOB NUMBER: 13-118
SHEET NAME: RP-01
SHT 7 OF 9

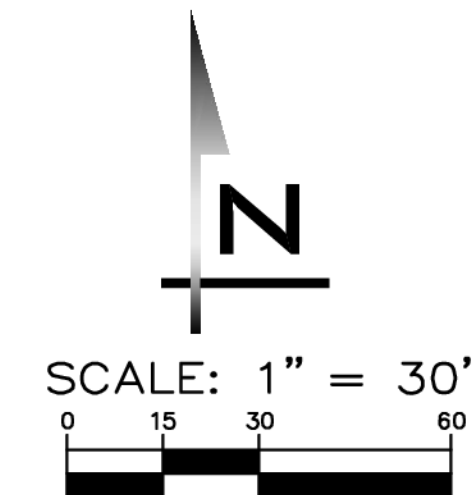

BLUELINE

25 CENTRAL WAY, SUITE 400,
KIRKLAND, WA 98033
P: 425.216.4051 F: 425.216.4052
WWW.THEBLUELINEGROUP.COM

SCALE:
AS NOTED

PROJECT MANAGER:
BRETT K PUDISTS, PE

PROJECT ENGINEER:
LYNDEY FEDAK, PE

DESIGNER:
AARON C LANCE

ISSUE DATE:
2/16/2023

TREE NOTES

- THERE ARE 17 REGULATED TREES, 1 VIALBE AND 16 NON-VIALBE.
- TREE #2 IS REGULATED AND VIALBE AND WILL REMAIN. 100% OF REGULATED VIALBE TREES WILL BE RETAINED AND PROTECTED.
- 16 REGULATED TREES ARE NON-VIALBE. 1 WILL REMAIN AND 15 WILL BE REMOVED. 25 ARE REQUIRED TO BE REPLANTED PER TREE REPLACEMENT TABLE ON SHEET TR-02. 38 TREES ARE PROPOSED TO BE PLANTED.

PROPOSED TREE REPLACEMENT

REPLACEMENT LOCATION	NUMBER OF TREES
RIGHT-OF-WAY	19
PARCELS	18
TOTAL	37

REPLACEMENT TREES

PLANT SCHEDULE

TREES	CODE	QTY	BOTANICAL / COMMON NAME	CONT	SIZE	TREE HEIGHT AT MATURITY	NATIVE / ADAPTIVE
	AB	10	ACER RUBRUM 'BOWHALL' BOWHALL MAPLE	B & B	2" CAL	UP TO 40'	NORTHWEST ADAPTIVE
	AG2	6	AMELANCHIER X GRANDIFLORA 'AUTUMN BRILLIANCE' 'AUTUMN BRILLIANCE' SERVICEBERRY	B & B	2" CAL	UP TO 25'	NORTHWEST ADAPTIVE
	CP	6	CHAMAECYPARIS NOOTKATENSIS 'PENDULA' WEEPING NOOTKA FALSE CYPRESS	B & B	8" MIN PLANTED HT.	UP TO 25'	NORTHWEST ADAPTIVE
	PC	9	PYRUS CALLERYANA 'CHANTICLEER' CHANTICLEER PEAR	B & B	2" CAL	UP TO 25'-35'	NORTHWEST ADAPTIVE
	TE	6	THUJA PLICATA 'EXCELSA' WESTERN RED CEDAR	B & B	8" MIN PLANTED HT.	ABOUT 30'	NORTHWEST NATIVE

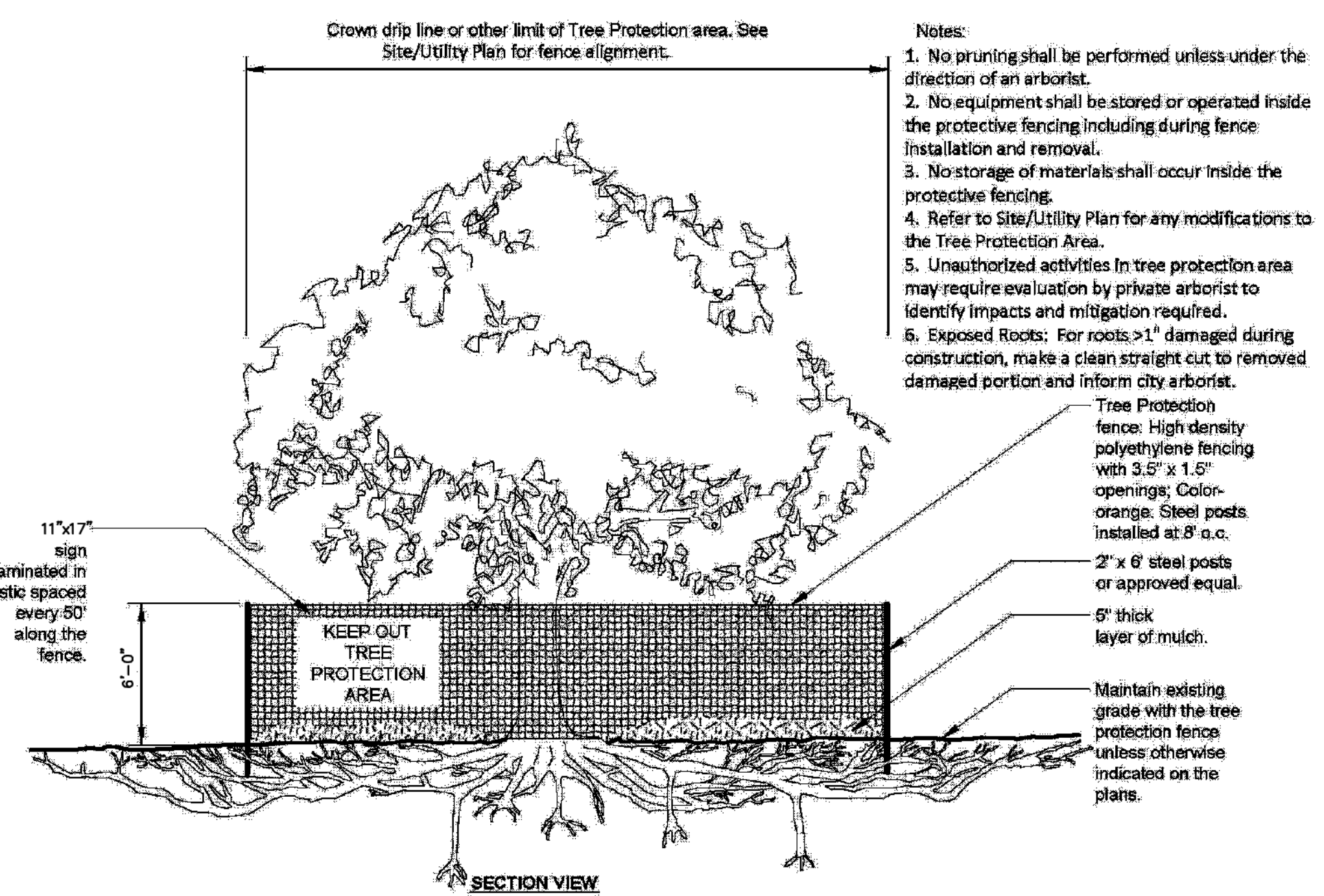

TREE PROTECTION DETAIL
NOT TO SCALE

UNDERGROUND UTILITY NOTE

UNDERGROUND UTILITIES ARE SHOWN IN THE APPROXIMATE LOCATION. THERE IS NO GUARANTEE THAT ALL UTILITY LINES ARE SHOWN, OR THAT THE LOCATION, SIZE AND MATERIAL IS ACCURATE. THE CONTRACTOR SHALL UNCOVER ALL INDICATED PIPING WHERE CROSSING, INTERFERENCES, OR CONNECTIONS OCCUR PRIOR TO TRENCHING OR EXCAVATION FOR ANY PIPE OR STRUCTURES, TO DETERMINE ACTUAL LOCATIONS, SIZE AND MATERIAL. THE CONTRACTOR SHALL MAKE THE APPROPRIATE PROVISION FOR PROTECTION OF SAID FACILITIES. THE CONTRACTOR SHALL NOTIFY ONE CALL AT 8-1-1 (WASHINGTON1.COM) AND ARRANGE FOR FIELD LOCATION OF EXISTING FACILITIES BEFORE CONSTRUCTION.

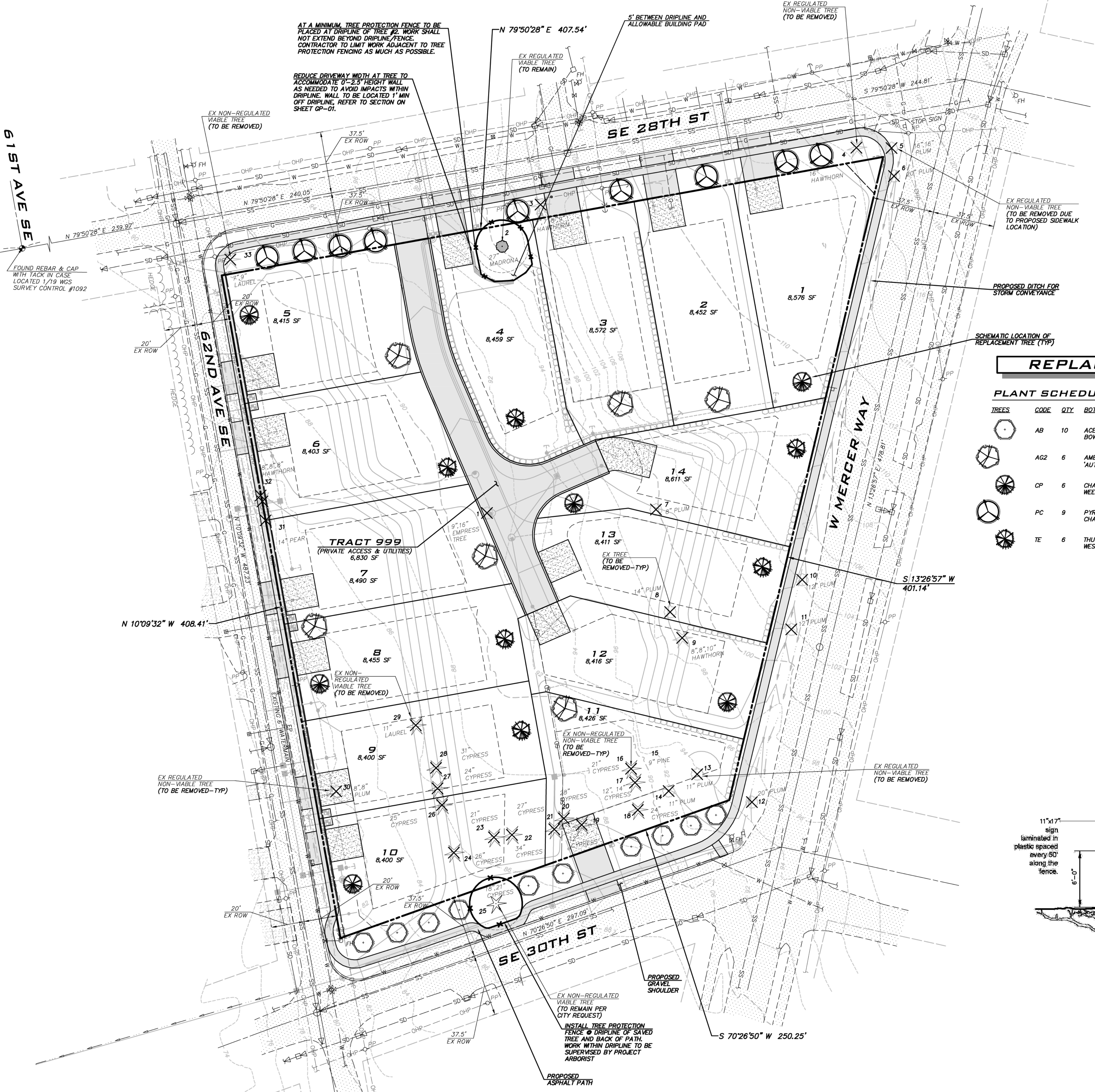

REVISIONS

NO	DATE	BY	REASON
1	2/16/23	MWK	REVISION PER CITY COMMENTS
2	2/16/23	MWK	REVISION PER CITY COMMENTS
3	2/16/23	MWK	REVISION PER CITY COMMENTS

PRELIMINARY TREE RETENTION AND REPLACEMENT PLAN
2825 W MERCER WAY
PRELIMINARY PLAN
 PARCEL #2174502425
 CITY OF MERCER ISLAND WASHINGTON

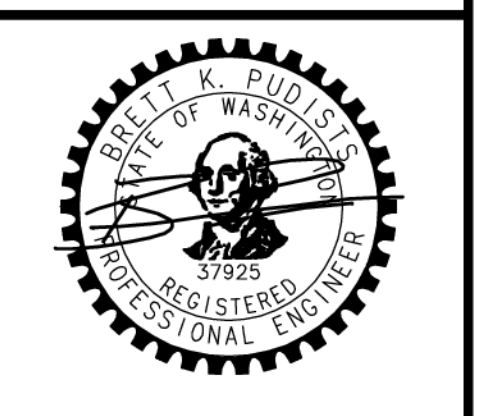

2/16/23
JOB NUMBER:
13-118
SHEET NAME:
TR-01
SHT **8** OF **9**

Mike O'Brien, OB Mercer Island Properties
RE: Arborist Report, 2825 West Mercer Way, Mercer Island WA
February 21, 2019
Page 9 of 11

Attachment No. 3 – Regulated Tree Inventory (Boldface tree to be retained)

Regulated Threshold	Regulated Category	> 24" DBH	Tree No. *	DBH (in.)	QMD	Common name/Latin name	Drip-line Radius	Health	Structure	Comments on Condition	Tree Type	Viable Tree?
36"	Significant		1	9,16"	18"	Empress tree, Paulownia tomentosa	20'	1	2	Asymmetric canopy	D	No
6"	Exceptional	Yes	2	27"		Madrone, Arbutus menziesii	16'	1	1		BE	Yes
16"	Significant		3	7,7,8,9"	15"	English hawthorn, Crataegus monogyna	12'	2	3	Diseased, stumpsprout	D	No
16"	Exceptional		4	16"		English hawthorn, Crataegus monogyna	15'	2	3	Topped, double leader, over mature	D	No
21"	Exceptional		5	16,16"	23"	Bilreiana flowering plum, Prunus bilreiana	16'	2	3	Double leader, over mature	D	No
21"	Significant		6	20"		Bilreiana flowering plum, Prunus bilreiana	16'	2	3	Over mature	D	No
21"	Significant		7	8"		Bilreiana flowering plum, Prunus bilreiana	15'	2	3	Over mature	D	No
21"	Significant		8	14"		Bilreiana flowering plum, Prunus bilreiana	14'	3	3	Suckers, over mature, fungal conks on trunk	D	No
16"	Significant		9	8,8,10"	15"	English hawthorn, Crataegus monogyna	18'	2	3	Diseased, topped, stumpsprout	D	No
21"	Significant		10	12"		Bilreiana flowering plum, Prunus bilreiana	14'	3	3		D	No
21"	Significant		11	12"		Bilreiana flowering plum, Prunus bilreiana	7'	3	3	Diseased, branch decline, decay	D	No
21"	Significant		12	20"		Bilreiana flowering plum, Prunus bilreiana	16'	3	3		D	No
21"	Significant		13	11"		Bilreiana flowering plum, Prunus bilreiana	12'	1	3	Root failure	D	No
21"	Significant		14	11"		Bilreiana flowering plum, Prunus bilreiana	16'	2	2	Over mature, roots at soil surface	D	No
NR			16	21"		Leyland cypress, Cupressus xleylandii	16'	1	2		C	No
NR			17	12,14"	18"	Leyland cypress, Cupressus xleylandii	13'	1	2	Asymmetric (hedge against existing building)	C	No
NR		Yes	18	24"		Leyland cypress, Cupressus xleylandii	15'	1	2		C	No

Greenforest Registered Consulting Arborist

Mike O'Brien, OB Mercer Island Properties
RE: Arborist Report, 2825 West Mercer Way, Mercer Island WA
February 21, 2019
Page 10 of 11

Regulated Threshold	Regulated Category	> 24" DBH	Tree No. *	DBH (in.)	QMD	Common name/Latin name	Drip-line Radius	Health	Structure	Comments on Condition	Tree Type	Viable Tree?
NR			19	12"		Leyland cypress, Cupressus xleylandii	16'	1	2		C	No
NR		Yes	20	28"		Leyland cypress, Cupressus xleylandii	16'	1	2		C	No
NR		Yes	21	27"		Leyland cypress, Cupressus xleylandii	16'	1	2		C	No
NR		Yes	22	34"		Leyland cypress, Cupressus xleylandii	16'	1	2		C	No
NR			23	21"		Leyland cypress, Cupressus xleylandii	16'	1	2		C	No
NR		Yes	24	26"		Leyland cypress, Cupressus xleylandii	16'	1	2		C	No
NR		Yes	25	18,21"	27"	Leyland cypress, Cupressus xleylandii	16'	1	1		C	Yes
NR		Yes	26	25"		Leyland cypress, Cupressus xleylandii	16'	1	2		C	No
NR		Yes	27	24"		Leyland cypress, Cupressus xleylandii	16'	1	2	Asymmetric (hedge against existing building)	C	No
NR		Yes	28	31"		Leyland cypress, Cupressus xleylandii	16'	1	2		C	No
NR			29	11"		Portugal laurel, Prunus lusitanica	10'	1	1		BE	Yes
36"	Significant		30	8,8"	11"	Plum (seedling), Prunus domestica	15'	3	3	Diseased, topped, decay, lean	D	No
36"	Significant		31	14"		Pear, common, Pyrus communis	16'	2	3	Topped, covered in ivy	D	No
16"	Significant		32	8,8,8"	13"	English hawthorn, Crataegus monogyna	15'	2	3	Multiple ldrs, lean, ivy	D	No
NR			33	7,9"	11"	Portugal laurel, Prunus lusitanica	12'	1	2	Double leader	BE	Yes

NR = Not Regulated
Tree numbers are non-sequential because 3 small trees included in the previous inventory are removed from this report.

Greenforest Registered Consulting Arborist

CITY OF MERCER ISLAND

COMMUNITY PLANNING & DEVELOPMENT
9611 SE 36TH STREET | MERCER ISLAND, WA 98040
PHONE: 206.275.7605 | www.mercer.gov



TREE INVENTORY & REPLACEMENT SUBMITTAL INFORMATION

EXCEPTIONAL TREES

Exceptional Trees - means a tree or group of trees that because of its unique historical, ecological or aesthetic value constitutes an important community resource. A tree that is rare or exceptional by virtue of its size, species, condition, cultural/historical importance, age, and/or contribution as part of a tree grove. Trees with a diameter of more than 36 inches, or with a diameter that is equal to or greater than the diameter listed in the Exceptional Tree Table shown in MICC 19.16 under Tree, Exceptional.

List the total number of trees for each category and the tree identification numbers from the arborist report.

Number of trees 36" or greater: 0

List tree numbers: _____

Number of trees 24" or greater (including 36" or greater): 1

List tree numbers: 2

Number of trees from Exceptional Tree Table (MICC 19.16): 0

List tree numbers: _____

LARGE REGULATED TREES

Large Regulated Trees - means any tree with a diameter of 10 inches or more, and any tree that meets the definition of an Exceptional Tree.

Number of Large Regulated Trees on site: 1 (A)

List tree numbers: _____

Number of Large Regulated Trees on site proposed for removal: 0 (B)

List tree numbers: _____

Percentage of trees to be retained ((A-B)/Ax100) note: must be at least 30%: 100 %

RIGHT OF WAY TREES

Right of Way Trees - means a tree that is located in the street right of way adjacent to the project property.

Number of Large Regulated Trees in right of way: 0

List tree numbers: _____

Number of Large Regulated Trees in right of way proposed for removal: 0

List tree numbers: _____

\\chfs1\share\CPD\FORMS\1Current Forms\Engineering Forms\TreeInventoryReplacementSubmittalInformation.docx 1/2019

List tree numbers: _____

Reason for removal: _____

TREE REPLACEMENT

Tree replacement- removed trees must be replaced based on the ratio in the table below. Replacement trees shall be conifers at least six feet tall and or deciduous at least one and one-half inches in diameter at base.

Diameter of Removed Tree (measured 4.5' above ground)	Tree replacement Ratio	Number of Trees Proposed for Removal	Number of Tree Required for Replacement Based on Size/Type
Less than 10" and non-viable trees	1	13	13
10" up to 24"	2	0	0
Greater than 24" up to 36"	3	0	0
Greater than 36" and any Exceptional Tree	6	2	12
TOTAL TREE REPLACEMENTS			25 required
			37 provided

\\chfs1\share\CPD\FORMS\1Current Forms\Engineering Forms\TreeInventoryReplacementSubmittalInformation.docx 1/2019



BLUELINE

25 CENTRAL WAY, SUITE 400,
KIRKLAND, WA 98033
P: 425.216.4051 F: 425.216.4052
WWW.THEBLUELINEGROUP.COM

SCALE:
AS NOTED

PROJECT MANAGER:
BRETT K PUDISTS, PE

PROJECT ENGINEER:
LYNDEY FEDAK, PE

DESIGNER:
AARON C LANCE

ISSUE DATE:
2/16/2023

NO	DATE	BY	REVISIONS		
			REVISIONS	REVISIONS	REVISIONS
1	7/2/21	MWK	REVISIONS PER CITY COMMENTS		
2	10/22/21	MWK	REVISIONS PER CITY COMMENTS		
3	2/16/23	MWK	REVISIONS PER CITY COMMENTS		

TREE TABLES
 2825 W MERCER WAY
 PRELIMINARY PLAT
 PARCEL #2174502425
 CITY OF MERCER ISLAND WASHINGTON



2/16/23

JOB NUMBER:
13-118

SHEET NAME:
TR-02

SHT 9 OF 9

UNDERGROUND UTILITY NOTE

UNDERGROUND UTILITIES ARE SHOWN IN THE APPROXIMATE LOCATION. THERE IS NO GUARANTEE THAT ALL UTILITY LINES ARE SHOWN, OR THAT THE LOCATION, SIZE AND MATERIAL IS ACCURATE. THE CONTRACTOR SHALL UNCOVER ALL INDICATED PIPING WHERE CROSSING, INTERFERENCES, OR CONNECTIONS OCCUR PRIOR TO TRENCHING OR EXCAVATION FOR ANY PIPE OR STRUCTURES, TO DETERMINE ACTUAL LOCATIONS, SIZE AND MATERIAL. THE CONTRACTOR SHALL MAKE THE APPROPRIATE PROVISION FOR PROTECTION OF SAID FACILITIES. THE CONTRACTOR SHALL NOTIFY ONE CALL AT 8-1-1 (WASHINGTON11.COM) AND ARRANGE FOR FIELD LOCATION OF EXISTING FACILITIES BEFORE CONSTRUCTION.